

Zackenbergl Ecological Research Operations

# GeoBasis

Guidelines and sampling procedures for the geographical  
monitoring programme of Zackenberg Basic



Ver. January 2018

Kirstine Skov  
Charlotte Sigsgaard  
Maria Rask Mylius  
Magnus Lund

Department of Bioscience, Aarhus University  
&  
Department of Geosciences and Natural Resource  
Management, University of Copenhagen

## **This edition of the GeoBasis Manual**

Please note that GeoBasis procedures are regularly improved in order to ensure both continuity in the long term measurements and state of the art procedures. The GeoBasis manual is therefore, per definition, always under construction.

If you have any questions or comments to this edition please contact:

Kirstine Skov

Department of Bioscience

Aarhus University

E-mail: [ksk@bios.au.dk](mailto:ksk@bios.au.dk) or [ksk@ign.ku.dk](mailto:ksk@ign.ku.dk)

Phone: +45 93 50 87 57

## **Acknowledgements**

The GeoBasis manual is based on guidelines and experiences given by the scientific consultants, fieldworkers, labworkers and managers who have been involved in the GeoBasis monitoring programme throughout the last twenty years. Therefore, we would like to thank the following people: Ole Humlum, Hanne Hvidtfeldt Christiansen, Bo Elberling, Bjarne Holm Jakobsen, Stina N. Rasmussen, Morten Rasch, Hans Meltofte, Jørgen Hinkler, Thomas Friberg, Claus Nordstrøm, Henrik Søgaaard, Bent Hasholt, Sten B. Pedersen, Jens Søndergaard, Henriette Ambro, Mikkel Peter Tamstorf, Julie Marie Falk, Charlotte Sigsgaard, Torben Røjle Christensen, Mikhail Mastepanov, Lau Gede Petersen, Laura Helene Rasmussen, Line Vinther Hansen, Hanna Modin, Daniel Alexander Rudd, Maria Voigt Sonnichsen, Stine Højlund Pedersen, Efrén Lopez-Blanco, Gillian Simpson, Andreas Westergaard-Nielsen, Stefanie Cable, Marcin Antoni Jackowicz-Korczynski and Maria Rask Mylius

Magnus Lund, Birger Ulf Hansen and Kirstine Skov

## **Front cover illustration**

Overview of GeoBasis/ICOS site MM2 in the fen. Photo credit: Konsta Punkka.

# Contents

<b>1</b>	<b>Introduction</b>	<b>1</b>
1.1	Zackenbergl . . . . .	1
1.2	The GeoBasis program . . . . .	2
1.3	Daily journal . . . . .	4
1.4	The GEM database . . . . .	4
1.5	Field season . . . . .	4
1.6	Getting around in the area . . . . .	4
1.7	Safety . . . . .	4
1.8	GeoBasis staff . . . . .	6
1.9	Scientific consultants . . . . .	7
<b>2</b>	<b>Automatic meteorological monitoring</b>	<b>8</b>
2.1	Introduction . . . . .	8
2.2	Automatic Meteorological stations (M2, M3, M7, M8, MM1 and MM2) . .	9
2.3	Offloading data from automatic weather stations . . . . .	11
2.3.1	Offloading data from automatic weather stations (CR1000 loggers) in the field . . . . .	12
2.3.2	Offloading data from CR1000 data logger by changing CF card in the field . . . . .	13
2.3.3	Retrieving data from CF card (at the office) . . . . .	14
2.3.4	Offloading data from automatic weather stations via wireless connection	15
2.3.5	Input of data into the local database . . . . .	16
2.3.6	Quick validation of data . . . . .	16
2.3.7	Formatting CF Cards . . . . .	16
2.4	Install program on the data logger . . . . .	17
2.5	Maintenance . . . . .	18
2.5.1	Troubleshooting . . . . .	18
<b>3</b>	<b>Snow monitoring</b>	<b>20</b>
3.1	Introduction . . . . .	20

3.1.1	Research application of snow observations . . . . .	21
3.2	Automatic snow depth measurements . . . . .	21
3.2.1	Offloading the Snow Pack Analyzer (SPA) . . . . .	22
3.2.2	Quick validation . . . . .	22
3.3	Manual snow depth measurements . . . . .	23
3.3.1	Input of data into the local database . . . . .	28
3.3.2	Quick validation of data . . . . .	28
3.4	Snow density, snow water equivalent (SWE) . . . . .	28
3.5	Making snow pits . . . . .	29
3.5.1	Input of data into the local database . . . . .	31
3.5.2	Determination of bulk density . . . . .	31
3.5.3	Input of data into the local database . . . . .	33
3.5.4	Maintenance . . . . .	33
3.5.5	Troubleshooting . . . . .	33
3.6	Snow cover and snow depletion . . . . .	33
3.6.1	Manual snow cover monitoring . . . . .	34
3.6.2	Input of data into local data base . . . . .	35
<b>4</b>	<b>Automatic digital camera monitoring</b>	<b>36</b>
4.1	Introduction . . . . .	36
4.2	Automatic snow and ice cover monitoring . . . . .	37
4.2.1	Offloading cameras . . . . .	39
4.2.2	Camera settings . . . . .	40
4.2.3	Timer settings . . . . .	40
4.2.4	Input of data into the local database . . . . .	40
4.2.5	image analysis . . . . .	40
4.2.6	Maintenance . . . . .	40
4.2.7	Trouble shooting . . . . .	40
4.3	Automatic camera at glacier lake . . . . .	41
4.3.1	Offloading the camera . . . . .	42
4.3.2	Camera settings . . . . .	42

4.3.3	Input of data into the local database . . . . .	42
4.3.4	Manual photomonitoring of Glacier dam . . . . .	42
4.4	Calibration of camera lens . . . . .	43
<b>5</b>	<b>Soil thaw and development of active layer</b>	<b>45</b>
5.1	Introduction . . . . .	45
5.2	Procedure for active layer measurements . . . . .	49
5.2.1	Maintenance . . . . .	49
5.2.2	Input of data into the local database . . . . .	49
5.2.3	Quick validation . . . . .	50
5.2.4	Input of data into international database . . . . .	50
<b>6</b>	<b>Temperature in snow, ground, air and water</b>	<b>52</b>
6.1	Introduction . . . . .	52
6.2	TinyTag data loggers . . . . .	54
6.2.1	Offloading data from the TinyTags . . . . .	61
6.2.2	Battery change . . . . .	61
6.2.3	Restart/launch data logger . . . . .	62
6.2.4	Input of data to the local database . . . . .	62
6.2.5	Quick validation of data . . . . .	62
6.2.6	Validation when connected to the internet . . . . .	63
6.2.7	Troubleshooting . . . . .	63
6.3	Geo-Precision permafrost temperature . . . . .	64
6.3.1	Offloading data from the Geo-Precision strings . . . . .	65
6.3.2	Battery change . . . . .	66
6.3.3	Contact regarding instrumentation of the temperature strings . . . . .	66
<b>7</b>	<b>Support of the ClimateBasis monitoring program</b>	<b>67</b>
7.1	The Climate station . . . . .	67
7.1.1	Data storing and power supply . . . . .	68
7.1.2	Input of data into the local database . . . . .	69
7.2	The Hydrometric station . . . . .	69

7.3	Contact: . . . . .	69
<b>8</b>	<b>River water monitoring</b>	<b>70</b>
8.1	Introduction . . . . .	70
8.2	Water level monitoring . . . . .	73
8.2.1	Manual water level monitoring . . . . .	73
8.2.2	Automatic water level monitoring . . . . .	76
8.2.3	Installation of OBS sensor, conductivity sensor and divers . . . . .	76
8.3	Water discharge measurements . . . . .	78
8.3.1	Manual discharge measurement using Q-liner . . . . .	79
8.3.2	Manual discharge measurements using the Valeport electromagnetic flow meter . . . . .	82
8.4	Level measurements by the bridge . . . . .	88
8.5	River water sampling . . . . .	94
8.5.1	Sampling water for suspended sediment 8:00 and 20:00 . . . . .	95
8.5.2	Sampling of water for chemical analysis at 8:00 . . . . .	96
8.5.3	Measure conductivity and temperature 8:00 and 20:00 . . . . .	96
8.5.4	In the Lab . . . . .	97
8.5.5	Maintenance of conductivity meter (Cond 3310) . . . . .	97
8.5.6	Input to the local database . . . . .	98
8.5.7	Quick validation of data . . . . .	98
<b>9</b>	<b>Procedure for Water handling</b>	<b>99</b>
9.1	Conductivity measurement . . . . .	99
9.2	pH measurement . . . . .	99
9.2.1	Maintenance pH meter . . . . .	100
9.3	Alkalinity measurement . . . . .	101
9.4	Preparation of samples prior to chemical analysis . . . . .	101
9.5	Suspended sediment . . . . .	102
9.5.1	Input of data to local database . . . . .	104
9.5.2	Quick validation of data . . . . .	104
9.6	Bottle and vial washing . . . . .	104

<b>10 Soil moisture and soil water monitoring</b>	<b>105</b>
10.1 Introduction . . . . .	105
10.1.1 Soil moisture . . . . .	105
10.1.2 Soil water chemistry . . . . .	106
10.2 Soil moisture and soil temperature . . . . .	107
10.2.1 Automatic soil moisture and temperature monitoring . . . . .	107
10.2.2 Manual soil moisture monitoring . . . . .	110
10.2.3 Manual soil moisture monitoring in ZEROCALM-2 . . . . .	111
10.3 Soil water . . . . .	112
10.3.1 Soil water extraction (heath) . . . . .	114
10.3.2 Collection of soil water . . . . .	115
10.3.3 Laboratory work . . . . .	116
10.3.4 Input of data to the database . . . . .	117
10.3.5 Quick validation of data . . . . .	117
10.3.6 Maintenance . . . . .	117
10.3.7 Troubleshooting . . . . .	117
10.3.8 Soil water extraction (fen) . . . . .	118
10.3.9 Collection of soil water . . . . .	118
10.3.10 Troubleshooting . . . . .	119
<b>11 Gas-flux monitoring</b>	<b>120</b>
11.1 Introduction . . . . .	120
11.2 Fluxmonitoring in the heath . . . . .	123
11.2.1 Installation of the micrometeorological station MM1 . . . . .	123
11.2.2 Licor - start-up . . . . .	125
11.2.3 Licor - shut-down . . . . .	126
11.2.4 Bi-weekly check of the micrometeorological station MM1 . . . . .	126
11.2.5 Troubleshooting . . . . .	127
11.2.6 Changing filters . . . . .	127
11.2.7 Calibration of the Li-7000 analyser . . . . .	128
11.2.8 Downloading data . . . . .	128

11.2.9	Quick validation of data . . . . .	128
11.2.10	Automatic camera at MM1 . . . . .	129
11.2.11	Preparation for winter storage . . . . .	129
11.3	Flux monitoring in the fen . . . . .	130
11.3.1	Installation of the micrometeorological station MM2 . . . . .	130
11.3.2	Licor7200 - start-up . . . . .	130
11.3.3	Bi-weekly check of the micrometeorological station MM2 . . . . .	131
11.3.4	Span and zero test of Licor7200 . . . . .	132
11.3.5	Internal chemicals and mirror cleaning . . . . .	136
11.3.6	Offloading of data from Li-7200 . . . . .	137
11.3.7	Automatic water level measurements at MM2 . . . . .	137
11.3.8	Automatic camera at MM2 . . . . .	137
11.3.9	Preparation for winter . . . . .	137
11.4	Flux monitoring at the Automatic Chamber (AC) site . . . . .	137
11.4.1	Power supply . . . . .	138
11.4.2	Soil temperature . . . . .	138
11.4.3	Water table . . . . .	139
11.4.4	Dark chamber measurements . . . . .	141
11.4.5	Active layer . . . . .	142
11.4.6	Level measurement . . . . .	142
11.4.7	Chamber Volume measurements . . . . .	143
11.4.8	Overview of daily check . . . . .	143
11.4.9	Overview of weekly check . . . . .	143
11.4.10	Troubleshooting . . . . .	143
<b>12</b>	<b>Geomorphological monitoring</b>	<b>145</b>
12.1	Introduction . . . . .	145
12.1.1	Coastal cliff recession . . . . .	146
12.1.2	Measuring retreat rates . . . . .	147
12.1.3	Maintenance . . . . .	147
12.1.4	Input of data to the local database . . . . .	148



12.1.5	Input of data into international database . . . . .	148
12.2	Topographic changes at beach profiles . . . . .	148
12.2.1	Survey of topographic profiles . . . . .	149
12.2.2	Input of data to the local database . . . . .	150
12.2.3	Quick validation . . . . .	150
12.3	Detailed mapping of the coastline by DGPS . . . . .	150
12.3.1	Procedure . . . . .	151
12.3.2	Input of data to local database . . . . .	151
<b>A</b>	<b>Instrumentation of GeoBasis installations</b>	<b>152</b>
<b>B</b>	<b>GPS positions</b>	<b>162</b>
<b>C</b>	<b>DOY calendar</b>	<b>166</b>
<b>D</b>	<b>Zackenberg valley map (place names)</b>	<b>167</b>
<b>E</b>	<b>Zackenberg calley map (zones)</b>	<b>168</b>
<b>F</b>	<b>Zackenberg area map</b>	<b>169</b>
<b>G</b>	<b>Field Program (not included)</b>	<b>169</b>
<b>H</b>	<b>Field Charts (not included)</b>	<b>169</b>

# 1 Introduction

## 1.1 Zackenberg

Zackenberg is located in central northeast Greenland (74° 30' N, 20° 30' W) (Fig. 1). The area has a high arctic climate, with a longterm mean annual (1996-2016) air temperature of -9.2 °C and mean annual precipitation sum of 200 mm. Most of the precipitation falls as snow, and the water availability is thus regulated by topography and snow distribution patterns. The study area is mountainous with deep valleys and fjords. Mountain peaks reach 1000-1400 m. Because of the dry conditions, glaciers only occur in the mountains.

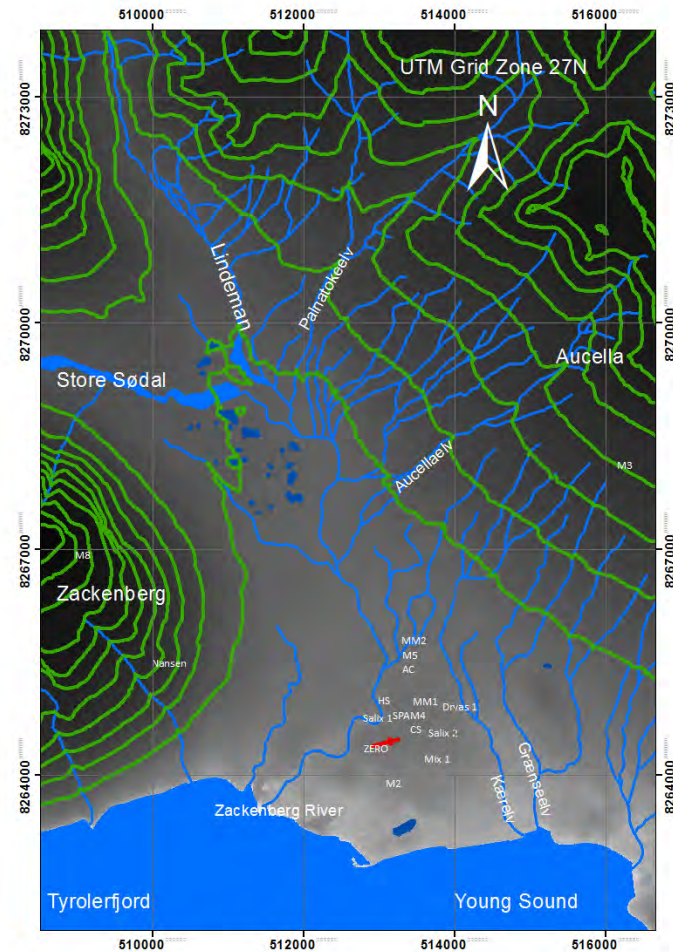

Figure 1: Map of GeoBasis and ClimateBasis plots referred to in the manual. Nansen blokken, the meteorological stations M2, M3, M4, M5 and M8, the soil water and moisture plots Salix 1, Salix 2, Dryas 1 and Mix 1, Automatic Chamber site (AC), the micro meteorological stations MM1 and MM2, the snow pack analyzer (SPA), the climate station (CS) and the hydrometric station (HS). The red cross indicates the location of the landing strip and the Zackenberg Research Station (ZERO).

The Zackenberg area has been covered by the Greenland Ice sheet several times. About 10,000 years ago, the lowland surrounding Zackenberg was deglaciated. Since then the land rise has been estimated to be ca. 70 m. The landscape dynamics in Zackenberg is highly variable in terms of bedrock, sediment type and topography. The Zackenberg valley can be divided into a western part dominated by gneiss and granite bedrock and an eastern part dominated by sedimentary and basaltic bedrock. These geological differences can also be seen in the different surface landforms in the area (Fig. 2). Zackenberg is situated within the continuous permafrost zone, and the landscape development is dominated by periglacial processes. The permafrost depth has been estimated to be approximately 300 m in the main valley area. The maximum thaw depth of the active layer generally varies between 0.45 and 0.85 m. Since monitoring of active layer depth began in 1997, the maximum thaw depth has increased by 1.0-1.5 cm per year.

The growing season lasts from late May in years with early snow melt, while in other years a continuous snow cover may prevail into early July. The peak in vegetation greenness generally occurs in late July/early August. The growing season generally ends in early September when temperatures fall below 0 °C.

## 1.2 The GeoBasis program

The GeoBasis monitoring program in Zackenberg and its sisters in Nuuk-Kobbefjord and Disko are funded by the Danish Energy Agency. The programs are part of the Greenland Ecosystem Monitoring ([www.g-e-m.dk](http://www.g-e-m.dk)). GeoBasis focuses on selected abiotic parameters in order to describe the state of Arctic terrestrial environments and potential feedback effects in a changing climate. As such, inter-annual variation and long-term trends are of paramount importance. The GeoBasis program is divided into a number of sub-programs, including:

- 1) Snow properties; including spatial and temporal variation in snow cover, depth and density.
- 2) Soil properties; spatially distributed monitoring of key soil parameters such as temperature, moisture, concentration of nutrient ions and seasonal progression of active layer depth.
- 3) Meteorology; monitoring of essential meteorological variables across various surface types and elevations.
- 4) Flux monitoring; plot and landscape scale flux monitoring of CO<sub>2</sub>, CH<sub>4</sub>, H<sub>2</sub>O and energy in wet and dry ecosystems.
- 5) Hydrology; monitoring of seasonal variation in river water discharge, chemistry and suspended sediment.
- 6) Geomorphology; monitoring of shorelines, coastal cliff foots and cross-shore profiles.

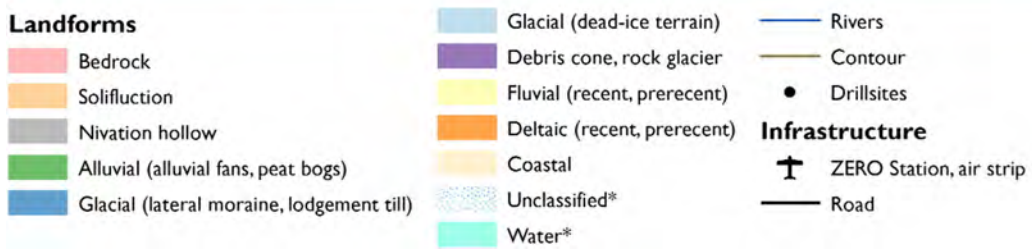
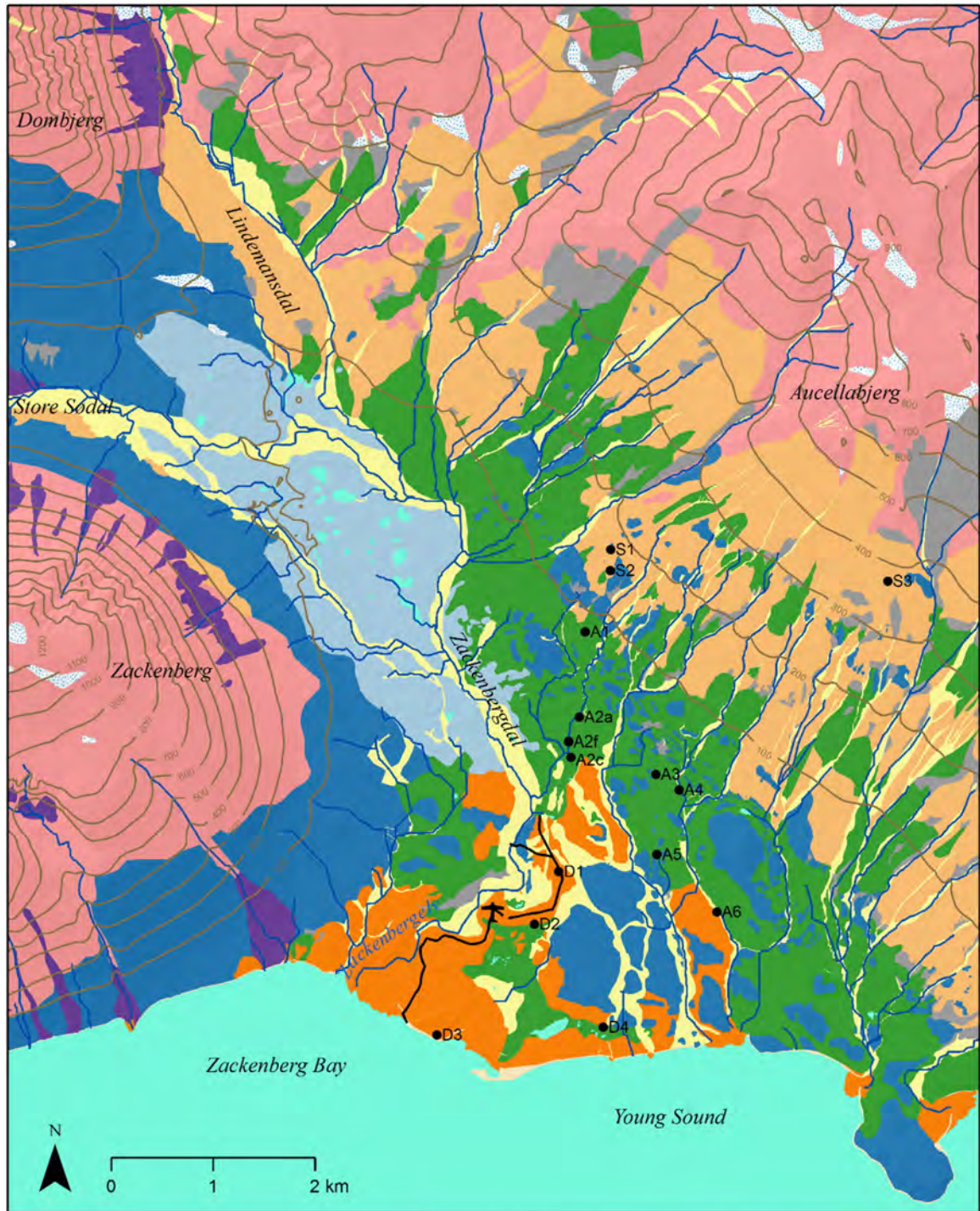

Figure 2: Geomorphological map of the Zackenberg valley (Cable et al., 2017)

### 1.3 Daily journal

During the field season the following must be recorded in a GeoBasis daily journal:

- Weather report (temperature, clouds, precipitation, wind, fog)
- Details about work carried out every day
- Condition of the Zackenberg river (sediment, colour/visibility, level, snow/ice drift)
- Snow cover distribution in the valley and on the slopes
- Condition and distribution of the sea ice and fjord ice
- Ideas and thoughts of improvement of the programme

### 1.4 The GEM database

Validated and quality checked data is freely available from [data.g-e-m.dk](http://data.g-e-m.dk).

### 1.5 Field season

The main field season runs from late May or early June and ends in late August or early September. However, since 2007 the season has been extended in both ends. Earliest start has been mid-March and latest closing has been early November. Locations of GeoBasis and ClimateBasis plots, referred to in the manual, are given in the map (Fig. 1). More detailed maps and UTM coordinates are given in the respective chapters and in App. B.

### 1.6 Getting around in the area

To protect the area in Zackenberg and minimize impact near the research sites and plots some rules must be respected. Please, study the ZERO site manual carefully for a description of the regulations in different zones of the valley. Staff from the monitoring programme must be prepared to give an introduction to the nearest surroundings and a guided tour when new people arrive at the station. An updated ZERO site manual can be downloaded from [zackenberg.dk](http://zackenberg.dk).

### 1.7 Safety

Always follow the safety instructions from the Zackenberg Research Station when you work in this remote area. GeoBasis has VHF radios and flare guns and share an Iridium satellite

telephone with BioBasis (+881641464327). Rifles and first aid kit can be borrowed from the Research Station.

**Polar bears** are regular visitors in the area. There have been several bear visits during field seasons. ALWAYS bring a rifle with you, when you work in the field. Please talk to the logistics at Zackenberg Research Station regarding polar bear safety.

## 1.8 GeoBasis staff

### **Magnus Lund (manager)**

Research Scientist, Ph.D.  
Ecosystem Ecology Group  
Department of Bioscience  
Aarhus University  
Frederiksborgvej 399  
DK-4000 Roskilde  
ml@bios.ua.dk

### **Birger Ulf Hansen**

Associate Professor, Ph.D.  
Department of Geoscience and Natural Resource Management  
University of Copenhagen  
Oster Voldgade 10  
DK-1350 Copenhagen K  
buh@ign.ku.dk

### **Kirstine Skov**

Department of Bioscience  
Aarhus University  
Frederiksborgvej 399  
4000 Roskilde  
ksk@bios.au.dk or ksk@ign.ku.dk

### **Marcin Antoni Jackowicz-Korczynski**

Department of Bioscience  
Aarhus University  
Frederiksborgvej 399  
4000 Roskilde  
mjk@bios.au.dk

### **Charlotte Sigsgaard**

Department of Geoscience and Natural Resource Management  
University of Copenhagen  
Oster Voldgade 10  
DK-1350 Copenhagen K  
cs@ign.ku.dk

## 1.9 Scientific consultants

Carbon dioxide and methane monitoring:

**Mikhail Mastepanov**

Ecosystem Ecology Group

Department of Bioscience

Aarhus University

Frederiksborgvej 399

DK-4000 Roskilde

mikhail.mastepanov@bios.au.dk

**Torben Røjle Christensen**

Ecosystem Ecology Group

Department of Bioscience

Aarhus University

Frederiksborgvej 399

DK-4000 Roskilde

torben.christensen@bios.au.dk

Soil water monitoring and chemistry:

**Bo Elberling**

Department of Geoscience and Natural Resource Management

University of Copenhagen

Oster Voldgade 10

DK-1350 Copenhagen K

be@ign.ku.dk

Automatic digital camera monitoring:

**Andreas Westergaard-Nielsen**

Department of Geoscience and Natural Resource Management

University of Copenhagen

Oster Voldgade 10

DK-1350 Copenhagen K

awn@ign.ku.dk



## 2 Automatic meteorological monitoring

### 2.1 Introduction

Meteorological parameters such as temperature, air pressure, humidity, snow depth, incoming and outgoing radiation, soil temperatures, soil moisture, soil heat flux, albedo, etc. are measured continuously at six permanent automatic weather stations (M2, M3, M7, M8, MM1 and MM2) and at the climate stations operated by ASIAQ (see chapter 7). The stations are scattered throughout the valley and at different elevations, to get a representative coverage of the whole study area. Fig. 3 show the mean monthly air temperature from four of the stations, from October 2012 to October 2013. M2 and the climate station are located in the valley, close to the Zackenberg research station, M3 is located on the slope of the Aucella mountain, 420 m a.s.l., and M7 is located in the Store Sødal valley, west of the Zackenberg valley. During the winter months the three valley stations have cooler mean temperatures compared to the station on Aucella. The phenomenon is due to temperature inversions, caused by cold air sinking down during calm weather.

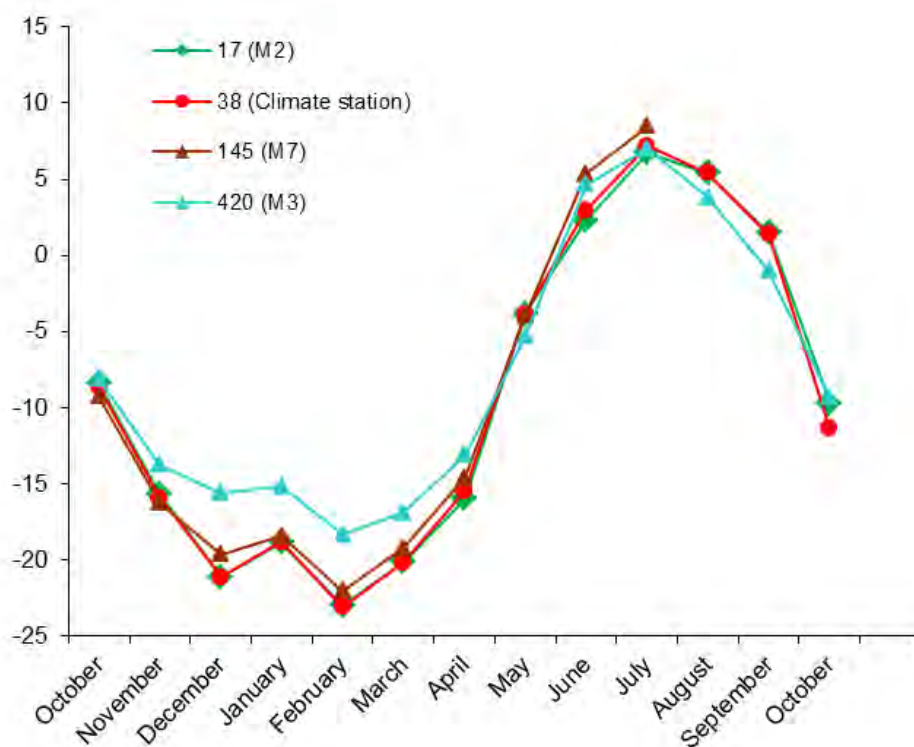

Figure 3: Mean monthly temperature from the meteorological stations M2 (17 m a.s.l.), the climate station (39 m a.s.l.), M3 (420 m a.s.l.) and M7 (145 m a.s.l.). Data is from the fall 2012 to fall 2013.

## 2.2 Automatic Meteorological stations (M2, M3, M7, M8, MM1 and MM2)

Location of the automatic weather stations is shown in Fig 1 and Fig 2.1-2.6. The stations are powered by batteries charged by solar panels. Batteries and data loggers are placed inside the enclosure mounted on the mast. All masts are logging data on CR1000 Campbell Scientific data loggers.

### Meteorological station (M2)

Located on a south facing slope in the ZC-2 grid, approximately 200 m south of the runway. The mast is situated on the border between an upper zone of Cassiope and a lower zone of Salix snow bed vegetation.

UTM: 8264019 mN, 513058 mE.

Elevation: 17 m a.s.l.

Operation: 2003-

Logging time: UTC+0

Instrumentation of the mast: Table 8, App. A

Data storage: CR1000 data logger, CFM100 Compact Flash Memory Module, PakBus address: 92

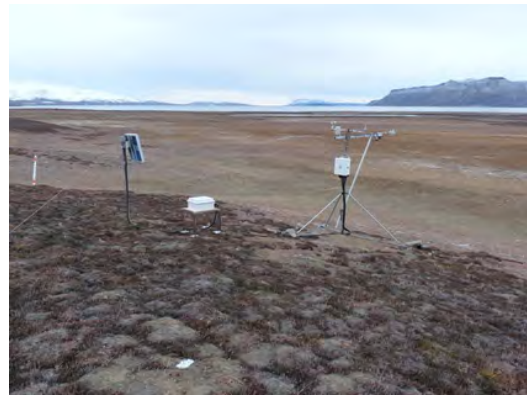

Figure 4: Meteorological station M2 in ZC-2. Looking South towards Daneborg.

### Meteorological station (M3)

Located on a gently south-west facing slope halfway up Aucellabjerg. Approximately 100 m north you find point 100 and 101 on the ZERO-line. The dominating vegetation is Salix.

UTM: 8268241 mN, 516124 mE.

Elevation: 420 m a.s.l.

Operation: 2003-

Logging time: UTC+0

Instrumentation of the mast: Table 9, App. A

Data storage: CR1000 data logger, CFM100 Compact Flash Memory Module, PakBus address: 93



Figure 5: Meteorological station M3. Looking East towards the top of Aucellabjerg.

### **Meteorological station (M7)**

Located in the western end of Store Sødal ca. 500 m west of the lake delta. The mast is placed in an almost flat open area on some big boulders. The vegetation between the boulders is a mix of grasses and Salix. Several small streams are running in the area.

UTM: 8269905 mN, 496815 mE.

Elevation: 145 m a.s.l.

Operation: 2008 -

Logging time: UTC+0

Instrumentation of the mast: Table 15, App. A

Data storage: CR1000 data logger, CFM100 Compact Flash Memory Module, PakBus address: 24

### **Meteorological station (M8)**

Located close to the top of Zackenberg. The mast is placed in an almost flat area. There is no vegetation and only rocks and boulders.

UTM: 8267060 mN, 508935 mE.

Elevation: 1144 m a.s.l.

Operation: 2013-

Logging time: UTC+0

Instrumentation of the mast: Table 16, App. A

Data storage: CR1000 data logger, CFM100 Compact Flash Memory Module, PakBus address: 98

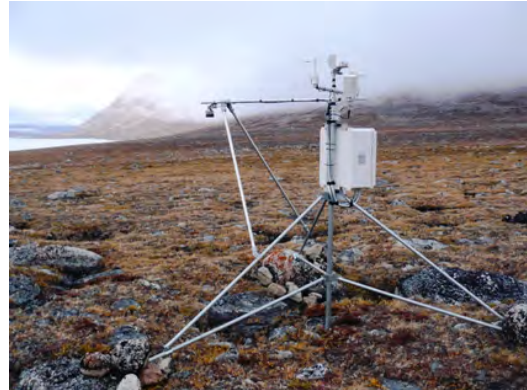

Figure 6: Meteorological station M7. Looking East towards the lake Store Sø and the north facing slope of Zackenberg.

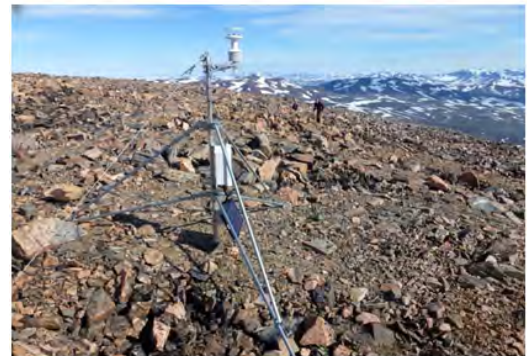

Figure 7: Meteorological station M8 close to the top of Zackenberg. Looking West towards the Aucella slope.

## MM1

The micrometeorological station (MM1) is located in a well-drained Cassiope heath site about 150 m north of the climate station (red cross at Fig 7.1).

Eddy mast: UTM: 8264887 mN, 513420mE

Battery box: UTM: 8264888 mN, 513403 mE

Elevation: 40 m a.s.l.

Operation period: 2000-

Logging time: UTC+0

Instrumentation of the mast: Table 10, App. A

Data storage: CR1000 data logger, CFM100 Compact Flash Memory Module, PakBus address: 991



Figure 8: MM1 with energy balance mast, behind eddy covariance tower and enclosure instruments.

## MM2

The micrometeorological station MM2 is located in a wet fen area “Rylekæret” (yellow circle at Fig 10.1). c. 300 m north of the Methane station.

Eddy mast: UTM: 8265810 mN, 513267 mE

Hut: UTM: 8265817 mN, 513283 mE

Elevation: 40 m a.s.l.

Operation period: 2009-

Logging time: UTC+0

Instrumentation of the mast: Table 11, App. A

Data storage: CR1000 data logger, CFM100 Compact Flash Memory Module, PakBus address: 992



Figure 9: MM2 with energy balance mast, behind precipitation gauge and eddy covariance tower.

## 2.3 Offloading data from automatic weather stations

There are three ways of offloading data from CR1000 loggers, via direct cable connection (section 2.3.1), by changing memory card (section 2.3.2) or by offloading data through

wireless connection (section 2.3.4). For the stations for which the wireless connection is working, this is the preferred method for offloading data. Changing CF cards should only be done about once or twice a year, unless there are problems with the mast. Offload through direct connection can be done every time the station is visited and is the preferred method for the stations to which there is no wireless connection.

### **Frequency**

Data is offloaded immediately/soon after arrival to Zackenberg and then approximately every third week throughout the main season (-see field program).

**Notice:** Keep walking around the masts to an absolute minimum. Use skies or snowshoes to minimize impact on the snow around and below the sensor in order not to influence the melt rate.

### **2.3.1 Offloading data from automatic weather stations (CR1000 loggers) in the field**

#### **Equipment to be used**

- Laptop/Tablet with Loggernet software
- Screw driver/Multi-tool
- USB to serial Campbell Scientific cable
- Folding rule to measure distance from SR50a to snow/ground surface (not M8)

1. Measure the exact distance from the SR50a sensor to the snow or ground surface with a folding rule to be able to calibrate the snow depths.
2. Take photos of the mast and surroundings to see the snow cover or vegetation below the sensors.
3. Undo the top and bottom screws on the white enclosure mounted on the mast and open it.
4. Connect the USB to serial cable to the CS IØport of the data logger.
5. Start the LoggerNet software and press [Connect] in the Main menu.
6. If it is the first time the computer connects to the data logger, first create a new setup. This is easily done via “EZSetup”. Use default settings. Pak bus address can be found in station status, under the flag status table.

7. Choose which data logger you want to connect to on the [Connect Screen] and press [Connect]. The cables in the bottom left will assemble. It's very important you choose the right logger.

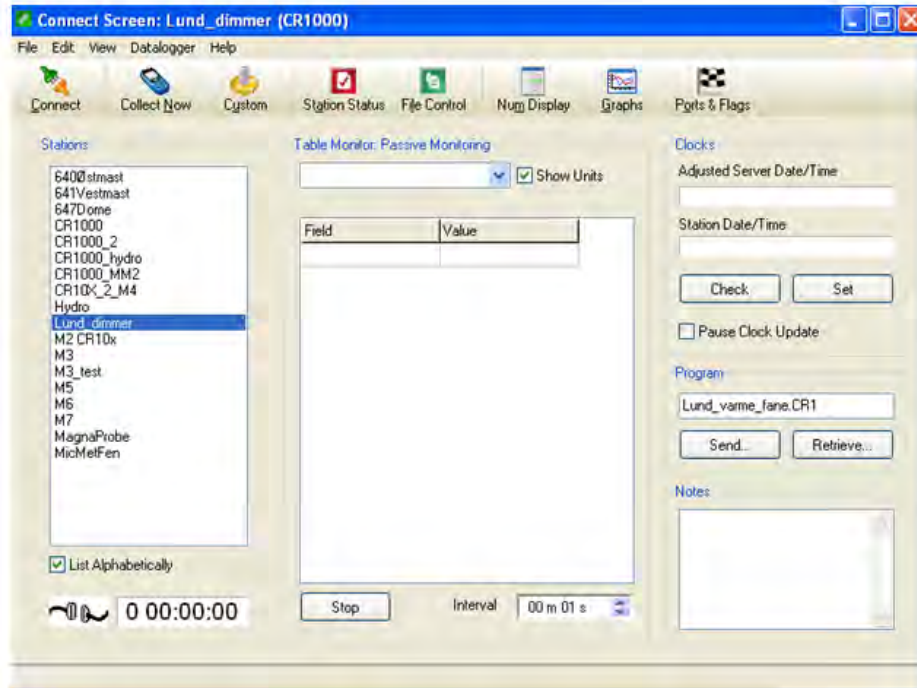

8. Under the menu press [Collect Now]

9. Data is now located in the default path (shown under 'Table Collection'). Make a safety backup of data and move it to the right station folder in the GeoBasis directory, depending on the station in question. Remember to name the file with the current date (Ex. M2\_yyyymmdd)

### 2.3.2 Offloading data from CR1000 data logger by changing CF card in the field

Offload from CR1000 loggers by changing the CF card should only be performed when the station is first visited in the spring, after the winter break or if there are problems with direct download that cannot be solved within a reasonable timeframe.

1. Bring a formatted Compact Flash II data card (file system FAT32, other formats

may also work, see section 2.3.7). It's very important, that the CF card is formatted and contains no files!!

2. Press [Remove Card] on the data logger (see Fig. 10). When the LED diode turns green you can remove the card from the CF module on the data logger.

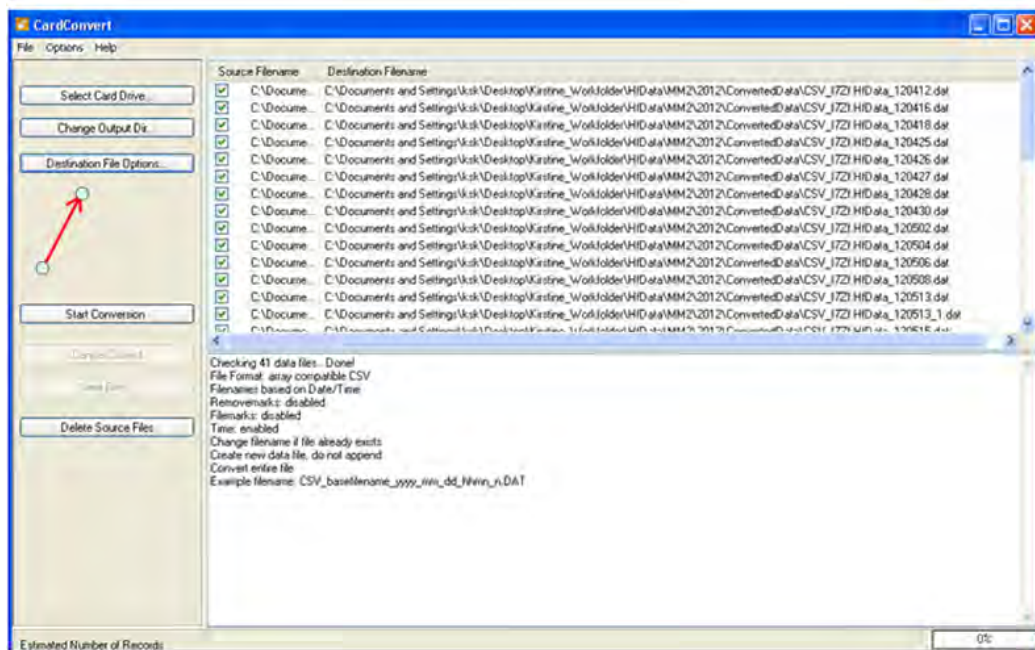

Figure 10: CFM100 Compact Flash Memory Module with diode turned off that indicates the CF card is ok (as on picture). If the Status LED is orange then the CF card is **NOT** working.

3. Insert the formatted Compact Flash II card in the data card slot. The data logger will now assign space for the associated tables on the card. While it does this the status diode flashes red (5-15 minutes, depending on the size of the card). Wait until the diode stops flashing. **If an error occurs the diode will turn orange right away when the card is placed in the module!** If the diode turns orange, then remove the card and either format it again or replace it with another **formatted** card. When the Status LED is turned off, the card is ok, see Fig. 10.

### 2.3.3 Retrieving data from CF card (at the office)

1. Copy all the data from the card to GeoBasis/MX/OriginalData and name is MX\_YYYY-MM-DD (and eventually 'HH:mm' if working with several files on one day), where X is the number of the station.
2. The data files from the CF card have a binary format that need to be translated into the format that we use: ASCII Table Data (TOA5). This is done by using the LoggerNet utility CardConvert back at the office.
3. Open LoggerNet and go to Data -> CardConvert
4. In 'Select Card Drive' browse to the location of the original data
5. In 'Change Output Dir...' browse to GeoBasis/MX/ConvertedData
6. In 'Destination File Options...':



Choose the default settings (File Format:ASCII Table Data (TOA5), no tickmarks under File Processing and File Naming and put tick marks in the first two options under TOA5-TOB1 Format) and press 'OK' and then 'Start Conversion'.

7. Include the extension YYYY-MM-DD in the file name in the 'ConvertedData' folder

### 2.3.4 Offloading data from automatic weather stations via wireless connection

In 2014 antennas were mounted on most masts with CR1000 loggers within the GeoBasis programme. The antennas transmit data from the CR1000 data loggers to House 5 at the Zackenberg research station through wireless connections. A stationary computer can be found in the storage room in House 5, on which Loggernet software has been installed. Connecting and downloading of data through the wireless connection is done using the Loggernet software on the stationary computer the same way as in section 2.3.1.

Data is automatically downloaded every night and automatically backed up on the synology (via SyncBack software). Data can be retrieved from the folder Loggerdata\_YYYY, copied to the folder in question GeoBasi/MX and the current date added as the extension to the file.



### 2.3.5 Input of data into the local database

Copy the retrieved data file to the GeoBasis directory (GeoBasis\_YYYY MM1, MM2, M2, M3, M4, M5, M7, M8/Original data). Open the file and check that the last logged value corresponds to the actual day of year (DOY) and time for removal of the storage module (DOY-calendar).

### 2.3.6 Quick validation of data

In order to check that sensors are (and have been) working satisfactory prepare a worksheet with a copy of data and make charts of every parameter.

- Check that the time series is OK. Insert a column of correct times and compare with the actual time column.
- Control that seasonal variation in parameters looks reasonable. If anything looks suspicious or if a sensor has failures or major dropouts, please email a report to the GeoBasis manager.

### 2.3.7 Formatting CF Cards

- Find a spare CF card for the station. For MM1 and MM2 it is important that the card type used is a 'Sandisk CompactFlash Ultra, 2 Gb or Campbell Scientific CF card (Note also that CF cards for MM1 should ONLY be changed when there is a thick snowpack or it's COMPLETELY dry around the mast, keep disturbance at a minimum!).
- Use a normal card reader (like the grey Kensington, labelled GEOBASIS found in House 4).
- Connect the card reader with the CF card to your computer.
- Locate the disk drive in 'My Computer'.

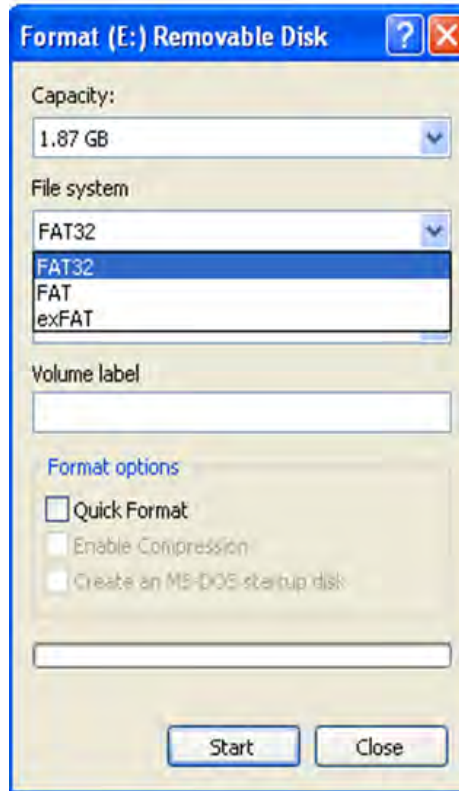

Figure 11: Format settings, when formatting CF card for a CR1000 data logger

- Right click on the drive and press [Format]. A new window will appear (Fig. 11) where you have to specify the format options. Change the 'File system' to [FAT32] and leave all other options as default values.
- Press [Start]. Click [OK] to the warning and [OK] when the format has finished.

## 2.4 Install program on the data logger

- Collect all data from the data logger before installing a new or modified program.
- Retrieve the old programme from the data logger before installing a new version. Turn on the computer and choose the Campbell software "Loggernet". Press [Connect] – specify station or data logger type – [Connect] - [Retrieve dld.program].
- Save the retrieved program into a folder named "Program " and save in GeoBasis\_YYYY/XX (where XX is the station ID, e.g. M2)/Program and name the file yyyy-mm-dd.
- To upload a new program, press [Send], browse to the new program. Make sure that the program works. Offload data after one hour and check values. Remember that

snow depth and soil moisture is not recorded in the first six hours after a program is uploaded.

## 2.5 Maintenance

- PLEASE observe that all stations in Zackenberg should run on local time (Greenwich mean time). In case of doubt; turn on your GPS and let it find > 3 satellites, read the local time on your GPS.
- Check that all sensors are mounted OK and that cables are covered by flexible steel or PVC conduit.
- The internal battery in the CR1000 data logger it has to be changed every fifth year. Follow separate manual: CR1000 measurement and control system.
- For maintenance, calibration and rotation of sensors please refer to Operators Manual for various sensors.
- Check silica gel bags when arriving at the station in the spring and replace silica gel bags before leaving the station for the winter.
- Before the stations are left, make sure that there is enough free space on the CF card.
- CNR1 sensors on M2 and M3 are calibrated every second year. [Description on how to change CNR1 sensors will follow after 2018 season, as the mounting system will be changed].

### 2.5.1 Troubleshooting

- User guides and Operator manuals for various sensors, data loggers, storage modules and support software are collected in House 4 and in the GeoBasis office in Copenhagen.
- Always check the power supply. Check voltage on the batteries.
- Check that the cables are connected in accordance with the wiring diagram and that cables are fixed in the data logger ports.
- Check that the time is correct on the data logger and on the computer. The time in Zackenberg is one hour behind GMT. All data loggers run local Zackenberg time. Solar noon in Zackenberg is 13:20.
- If the power for any reason has been cut, it might be necessary to re-install the program on the data logger. This is done via a computer, see section 2.4. Campbell CR1000

programmes for the stations are located in the GeoBasis directory: (GeoBasis/"name of the station" /programme/XX.dld).

- If you experience that the logger hasn't recorded any data for some time, but there is enough voltage on the battery, disconnect the powersupply, connect it to the logger again and upload the program. Check after half an hour or an hour whether any data has been logged.
- If the wireless connection to the station has been lost, try to remove wireless modem by the data logger (download data from the logger directly if necessary) and plug the wireless modem into the data logger again.
- If you aren't not able to connect to a certain data logger, check that you are using the correct baud rate and pakbus addresses, a list can be found on the GeoBasis computer.

### 3 Snow monitoring

#### 3.1 Introduction

Monitoring of the Arctic terrestrial snow cover and its snow properties is essential since they are key variables controlling Arctic ecosystem processes. As most of the precipitation in Zackenberg fall as snow, it plays a major role in the hydrological system. Especially during the snow-covered season where its insulating properties provides stable thermal conditions in the below-snow environment, including the vegetation cover and soil. However, the winter snow cover also has a direct impact on ecological dynamics and processes observed during the snow-free growing season. Particularly, the snowmelt timing regulates the plant flowering phenology, gas flux exchange, arthropod emergence, and avian breeding phenology and success.

Since 1995, a suite of ecologically-relevant snow variables are being recorded and include snow depth (both by sensors and manually probing in transect), snow density, snow stratigraphy, snow temperature, hardness, grain size and type.

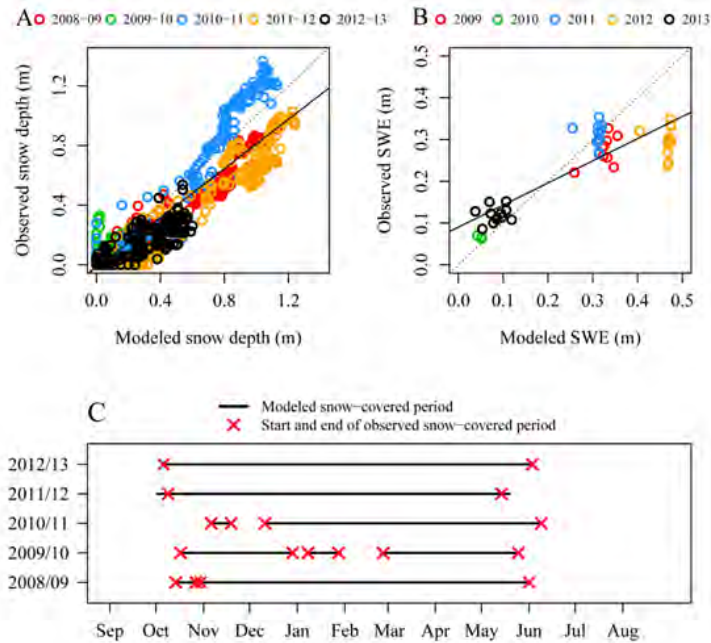

Figure 12: A: Regression between modeled and observed snow depth. Linear fit statistics (solid line):  $R^2 = 0.853$ ,  $P < 0.001$ . Dotted line is 1:1 line. B: Regression between modeled and observed snow water equivalent. Linear fit statistics (solid line):  $R^2 = 0.743$ ,  $P < 0.001$ . Dotted line is 1:1 line. C: Snow-covered periods, where modeled snow depth (black lines) is above 0.0 m in comparison with the observed timing (red crosses), of snow cover onset (albedo is above 0.8) and snow cover end (albedo is less than 0.2) from 2008 through 2013.

### 3.1.1 Research application of snow observations

The spatially distributed snow-evolution modelling scheme, SnowModel is currently implemented for eight years. SnowModel consists of three interconnected sub models, which are coupled with a high-resolution simple meteorological model, MicroMet. MicroMet uses meteorological inputs (see chapter 2) and include air temperature, relative humidity, wind speed and direction. The model also needs pre-melt snow water equivalents (SWE) from different locations throughout the Zackenberg valley. Furthermore, the collected snow depth, density, and SWE are used in the validation of SnowModel outputs (Fig. 12).

## 3.2 Automatic snow depth measurements

Snow depth is measured automatically by the meteorological stations (see chapter 2), by the climate station operated by ASIAQ (see chapter 7) and by the Snow Pack Analyzer (SPA), situated on the heath.

### Snow Pack Analyzer (SPA)

Located on the heath a couple hundred meters North of the Climate Station.

UTM: 8264934 mN, 513325 mE.

Elevation: 40 m a.s.l.

Operation: 2013-

Logging time: UTC+0

Instrumentation of the mast: Table 17, App. A

Data download: MDL logger and AISP logger

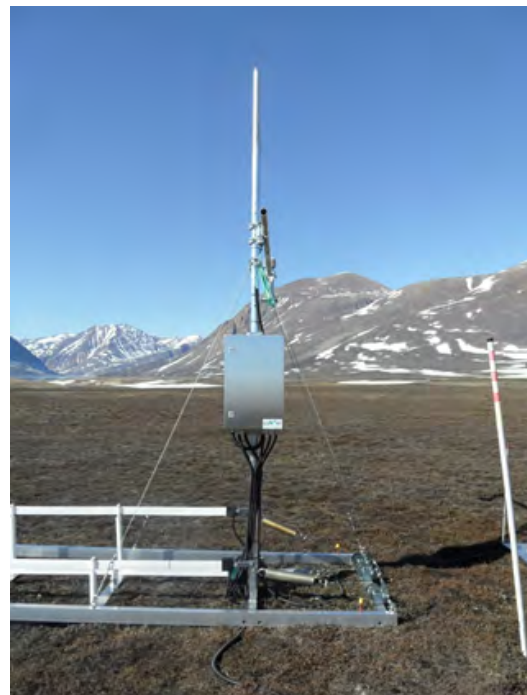

Figure 13: Snow Pack Analyzer. Looking West towards Zackenberg Mountain.

### 3.2.1 Offloading the Snow Pack Analyzer (SPA)

#### Equipment to be used

- PDA or computer with ComWin software (available in the Synology server)
- Multitool or special key for opening the box
- Manual including photos for offloading data from SPA “Offloading the Snow Pack Analyzer”

1. Inside the logger box, there are two loggers. One is called MDL, and the other AISP. Next to the MDL logger, a serial port with a cable is situated.
2. At the end of the serial cable, there is a USB-serial port converter. Connect the PDA to the USB-serial port converter.
3. Open the ComWin software on the PDA.
4. Establish a connection by clicking “Options” and choosing “Connection/modem” in the first window given.
5. A window will appear giving you the choice of ports. Click “OK”.
6. To offload data, press the icon in the top left corner saying “Show Current Data”.
7. You are asked to specify the type of protocol. Make sure the SOP3 (MDL, PD-2, PD-1) is ticked off and press “OK”.
8. You are now presented with a table with all measured parameters. Click “logger” in the top menu and press “Load Data”.
9. You are now presented with the logger’s Archive and Load Times. Specify from which date and time you wish to download data by changing “Load Time”.
10. Set the filename to the current date in the form of `yyyymmdd lod`.
11. Press “Load”.
12. The program will tell you how long data download will take and the elapsed time. It might take several minutes!

### 3.2.2 Quick validation

1. At the station, you can use the ComWin software to export the data to excel format.
2. Choose “Edit” and from the dropdown menu then “Convert data manually” and “choose which format you want the data in.”
3. You can then choose the source file, which is the one you downloaded in the field (It can in the PDA often be found on the C-drive under “DME” and “Daten”).

4. Choose the file with the date you created in the field and click “Convert”.
5. Now, the file should appear in the same folder, but in excel format.
6. Copy the data to the masterfile and check if it looks reasonable. Back it up in the Synology.

### 3.3 Manual snow depth measurements

In order to extend the number of point measurements for a better spatial coverage of the snow cover, snow depths are measured manually either with GeoRadar (see separate manual) or by probing using a Magnaprobe along transects in the valley (see Fig. 14 and 15). The end of winter snow pack in Zackenberg tends to be very hardly packed and manual depth measurements with a probe can be difficult. Also, ice layers can give a false impression of reaching the ground.

#### Location

Snow depths are measured along two transects within the valley (SNM-transect) and along the ZERO-line (SNZ-transect) (Fig 14). Snow depths are also measured in the entire ZEROCALM-1 grid net (see chapter 5). And finally, snow depths are measured along two lines in ZEROCALM-2 (see chapter 5, row 1 and row 6).

#### Frequency

Upon arrival in the beginning of the season (April-May): Snow depth surveys in ZC-1, ZC-2, SNM and SNZ should be performed as early as possible in order to get the end of winter snow accumulation.

Before the snow melt period starts: In case of significant snow fall, additional snow depth surveys in ZC-1 and ZC-2 should be performed. If time allows and if marked changes can be expected, additional snow depth surveys along SNZ are desirable.

During snow melt period: During snow melt period (i.e. when air temperature is above 0 °C for a few hours during midday and until snow has melted away), snow depth surveys should be performed every week in SNZ, ZC-1 and ZC-2, until there is liquid water in the snow pack.

During autumn/early winter (September/October): Snow depth surveys in ZC-1 and ZC-2 should be performed ca. every second week or after heavy snow fall (0.1-0.2 m). A snow depth survey along SNZ should be performed late in the season if the snow depth at the climate station exceeds 0.2 m.

#### SNM-Transect

The SNM-transect cover the lower part of the valley (Fig 14 and Table 1). Snow depths are



measured for approximately every 20 m, starting from Lomsø heading towards the moraine hills. Use a gps to aim for the fix points SNM1 to SNM7 (table 1). An alternative solution is to upload an SNM transect from previous years on the handheld GPS and follow that route. When aiming for one fix point, look for points in the landscape that you can steer after (e.g. mountain tops, snow-free outcrops on the mountain). You may see white nylon sticks/poles on your way, but these haven't been maintained for several years and finding the transect without a GPS is not feasible. On the way from SNM3-SNM4 you pass nearby the NE corner in ZC-1. When you are heading from SNM6-SNM7 the big antenna at the station can be used as a fix point.

### SNZ-Transect

The SNZ-transect starts in the old delta (Starting point SNZ-1 in Table 1) and ends just north of the meteorological station M3 located halfway up the mountain Aucellabjerg. All the way, the transect runs East of the ZERO-line. Use the gps to aim for the fix points SNZ-1 to SNZ-7 (Table 1). You may see white nylon sticks/poles on your way, but these haven't been maintained for several years and finding the transect without a GPS is not feasible.

Table 1: Fix point for SNM and SNZ - transects

ID	Northing	Easting	Description	ID	Northing	Easting	Description
SNM-1	8263425	513503	Near Lomsø	SNZ-1	8263626	512732	ZL-1
SNM-2	8263903	513648	Stake 2	SNZ-2	8264110	513038	ZL-12
SNM-3	8264686	513472	Stake 3	SNZ-3	8264161	513073	ZL-20
SNM-4	8266093	513538	Stake 5	SNZ-4	8265175	513714	ZL-38
SNM-5	8267089	513637	Stake 6	SNZ-5	8266178	514341	ZL-66
SNM-6	8265686	513190	Close to river	SNZ-6	8266903	514927	ZL-91
SNM-7	8264859	513361	NW-corner of ZC-1	SNZ-7	8268495	516152	c.100 m NE of M3

## Manual snow depth measurements using MagnaProbe (Transects)

### Equipment to be used

- Avalanche probe/steel probe (2-3 m)
- GPS-MagnaProbe (useful for snow depth up to 1.20 m, remember to charge the battery)
- GPS-MagnaProbe operating instructions (can be found in outside pocket of the MagnaProbe back pack)
- Folding rule, measuring tape
- Field book
- GPS incl. Fix points for SNM and SNZ transect
- Skies w. half-skis/Snowshoes
- Digital camera

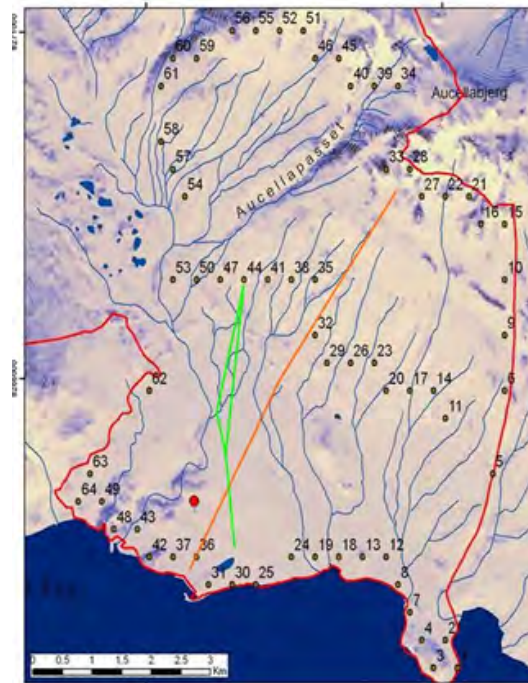

Figure 14: The orange line shows the SNZ-transect along the ZERO-line. The green line shows the SNM-transect. Numbered points refer to a snow depth campaign performed in 2008 for the IsiCab-project. The red dot is the Zackenberg Research station.

1. Test the MagnaProbe at the station, by making a calibration reading (one reading with the basket at the lowest possible position on the rod (simulating 0 cm snow depth), and one reading with the basket at the top of the rod (simulating 120 cm snow depth), following the short manual in the pocket of the MagnaProbe back pack.
2. Use map and GPS to find the starting point of the survey. Keep walking around the site to a minimum to prevent impact on the snow.
3. Record date, time and remarks about the snow surface condition (ice crust on the surface, smooth or wind-blown features on the surface, dust deposits, colour, tracks, how soft the snow is (Do you sink in with skis/snow shoes? etc.) in your notebook.
4. Before you start, the MagnaProbe should be calibrated again by making a record with the sliding basket in the lowest position and a record with the sliding basket in the highest position on the probe. The readings should be very close to 0 cm and 120 cm, respectively.

5. In order to make the first reading push the MagnaProbe vertically into the snow until you reach the ground (see Fig 15). The white basket floats on the snow surface. Press the thumb switch on the handle and make a reading of the snow depth (distance from the tip of the probe to the basket). The depth and a GPS position are recorded in the CR10x data logger when the reading is made. A double beep indicates that snow depth and GPS position are recorded. Make sure to penetrate possible ice lenses/layers in the snow pack, -or make a comment in your notebook if you doubt that you have reached the ground surface.

6. Use the GPS to walk in a straight line towards the next transect position (either SNM1-7 or SNZ1-7). Make a depth measurement for every 20 m. If there is no snow make a reading with the sliding basket in the lowest position for a 0 cm reading.

7. Snow depth more than 1.2 m is measured by the steel probe/avalanche probe and a corresponding 0 cm reading is recorded by the Magna probe. Write the number of the reading from the data logger (channel 1) display and note the depth measured by the rod in your notebook. In this way, the GPS position is recorded and the manual depth reading can be inserted in the final datasheet.

NB! If it is a snow rich year and if a majority of snow depth recordings along the transects can be expected to exceed 1.2 m, and using the GeoRadar for some reason isn't possible, you may consider performing fully manual recordings using the avalanche/steel probe. If that is the case, the interval between depth measurements can be decreased to every 50 m (instead of every 20 m).

8. Record any ice layers in the snow pack or basal ice on the ground in your notebook. Record distance from the surface of the snow to the ice layer/lens. Write remarks if you doubt that you have reached the ground surface and all other comments that can be helpful when validating the data.



Figure 15: Magnaprobe in use. The metal probe is pushed into the snow and down to the ground surface. The floating basket moves up and down and gives the position of the snow surface. The probe is connected to a CR10x datalogger. A depth reading and a GPS position are made when you press the thumb switch on the handle.



Figure 16: The data logger in the back pack with GPS antenna, cable and switch to mount on the probe.

### Manual snow depth measurements (ZC-1-gridnet)

1. Go to the grid (see chapter 5 for location). Localize the four corners marked by orange traffic poles. Individual grid markers are covered in snow.
2. Try to establish the grid points. Use extra ranging poles to temporarily mark the end points of the lines/rows. **Notice:** If the snow is very soft, then avoid walking inside the grid. Instead, only do the measurements in a square between the four corners.
3. Probe/measure the snow depth for every **second meter** (make sure you are in the line). Follow the instructions from the MagnaProbe manual.

### Manual snow depth measurements (ZC-2-gridnet)

1. Go to the grid. Localize the NW and SW corners. Only the four poles marking the corners of the grid and the northern part of the grid net can be used for location as individual grid markers are likely to be covered in snow.
2. Try to establish the two lines; row 1 and row 6. Use extra ranging poles to temporarily mark the end points of the lines. Row 1 runs from the NW-corner to the SW-corner. Row 6 is the parallel line 50 m away from row 1. Row 6 passes a few meters west of M2.
3. Probe/measure the snow depth for every **second meter** (make sure you are in the line).

### 3.3.1 Input of data into the local database

/Data from the MagnaProbe CR10X data logger must be offloaded according to the instructions for “dumping and processing data” in the MagnaProbe manual. Data from the MagnaProbe are saved in the GeoBasis directory (GeoBasis\_YYYY/Snow monitoring/snow depth/Magnaprobe/Original files/yyyy-mm-dd).

### 3.3.2 Quick validation of data

- Copy the data to an excel worksheet (use template from a previous year).
- Plot the GPS positions and check that the positions look reasonable.
- Insert all manual depth measurements ( $> 1.2$  m) in the datasheet.
- Insert a column with remarks and include comments from your notebook.
- Mark rows with test measurements and delete any recordings that should not be included in the final sheet (incorrect recordings, double measurements etc.).

## 3.4 Snow density, snow water equivalent (SWE)

Snow density and snow water equivalent (SWE) at the end of winter is an important input to the water balance of the area. Snow density is measured automatically by the SPA (see section 3.2) and manually, both as bulk density (average density for entire snow pack) and in snow pits (separate densities determined for different layers in the snow pack).

### Location

SWE (bulk density) is measured near the permanent snow masts at the climate station, the SPA and MM2. Snow pits are made near the grid net ZEROCALM-1 (in an area representative of the snow mast but outside the grid net) and near ZEROCALM-2 in the deep snow patch outside the grid. Samples should be taken at least 10 m away from the automatic stations in order to minimize impact on the snow.

### Frequency

SWE measurements should be performed before the snow melt period begins, in order to establish an end of winter SWE. Make snow pits with density sampling in each identified layer at Climate station and ZC-2 upon arrival in the beginning of the season. Furthermore, bulk density measurements during the snow melt period (period with above freezing air temperature) should be carried out once a week near the Climate Station/SPA and MM2.

### 3.5 Making snow pits

Snow pits are made in order to give a more detailed description of the snow pack and variation in snow density and temperature of different layers.

#### Frequency

At the end of winter a deep snow pit is made in the snow patch near ZC-2, -in the deep part but outside the grid net (to reduce impact). In the area near the Climate Station a pit is made several times during snow melt for a better description of the changes taking place.

#### Equipment to be used

- Snow shovels
- Folding rule
- Thermometers
- Paint brush
- Mass scale (kitchen scale or salter scale)
- RIP cutter (or short 4/20 cm steel tube)
- Metal shave plates
- Metal spatula/knife
- Field chart for snow pit and pen



Figure 17: Equipment used for sampling in the snow pit.

1. A pit is dug in undisturbed snow. Decide where you will have your profile wall in order to avoid disturbance of the snow surface in that end. The main wall of the snow pit must not receive direct sunlight during the measurements, as it will increase temperature readings.
2. Dig a pit all the way to the ground surface. Make the pit large enough for a person to make measurements. The wall facing away from the sun should be smooth and vertical.
3. Anchor the folding ruler to the wall. The zero point of the ruler must be at ground level. Extend the ruler straight up to the top snow level. Record total depth of the snow. Make sure you keep track of what is up and down in the recordings (where 0 cm is).



Figure 18: Snow pit without basal ice. Temperature recordings. Figure 19: A small ring (100 cm<sup>3</sup>) is used to sample the surface snow.

4. Measure temperature for every 10 cm (every 5 cm if the total depth of snow is less than 0.5m) by inserting temperature probes horizontally into the wall shortly after the pit is dug. Let readings stabilize for at least 2 minutes before the reading is made. Measure temperature to nearest 0.1°C. Calibrate thermometers in ice water before they are used in the profile. Temperature measurements should be taken immediately after digging to minimize errors/influence due to exposure.
5. Record the snow conditions (surface snow, ice layer and lenses in the profile, basal ice etc.). If there are any significant different layers, then write down the depth of where it starts and ends.
6. Record the weight of the empty sampling equipment.
7. Measure snow density by sampling a known volume of snow. Insert the RIP cutter at the depth you want to sample. Drive the lid of the RIP cutter into the snow pack and remove a complete volume carefully. If using steel tube, always remember to write the dimension (inner diameter and length) of the chosen tube and clean the ends of the tube with a sharp plate or knife.
8. Note the weight snow + sampling equipment.
9. Repeat the sampling 3 times in each layer.
10. Record the weight of the empty sampling equipment again after finishing all measurements and make sure it's the same as before.
11. For each layer record the 'hand hardness'. There are five categories: Fist, Four fingers, Finger, Pencil and Knife. First try to push your fist into the layer in question. The pressure applied should correspond to the pressure required for it to become uncomfortable when you press your fist against your nose. If it's possible to press your fist into the snow wall, note 'fist' in the field chart. If this is not possible try with four fingers, then one finger, a

pencil and a knife/metal plate, until the hardness of the snow can be determined.

11. Take photos of the pit.

### 3.5.1 Input of data into the local database

Data is saved in the GeoBasis directory (GeoBasis\_YYYY/Snow monitoring/Snow density). Calculate snow density and create a temperature profile for the pit wall.

#### Formulas

Volume of cylinder (sampling tube):  $\pi * r^2 * L$  ( $\pi = 3.1416$ ,  $r =$  inner radius of tube,  $L =$  length of tube)

Mass of snow in sampling tube: (mass of tube and snow – mass of empty tube)

Density of snow: mass of snow / Volume of snow

Density of snow, measured with RIP c. 250 cutter: mass of snow \* 4

Water Content (%): Density of snow \* 100

SWE: 70 cm of snow with a density of  $0.360g/cm^3 \sim (70 * 0.360) = 25.2$  mm water

### 3.5.2 Determination of bulk density

Follow instructions from the Snow Survey Sampling Guide (a short version is given here in this manual) and fill out the field chart for snow bulk density.

#### Equipment to be used

- Snow Survey Sampling Equipment (Snow-Hydro) consisting of four sampling tubes
- Spanner wrenches
- Thread protector
- Driving wrench
- Weighing scale and cradle
- Snow survey sampling guide
- Field chart for snow bulk density
- Handheld GPS

1. Go to the site. Find an undisturbed snow surface. Record the UTM position from the GPS.

2. Measure snow depth with a steel probe/avalanche probe.



3. Assemble sampling tube by screwing tube sections together hand tight. Make sure numbers on the scale run consecutively. Before taking a sample, make sure that there is no dirt or snow inside the tube. Weigh the empty tube.
4. Hold the sampling tube vertically and drive it through the snow pack. Make sure that the cutter penetrates all the way to the ground surface. Before lifting up the tube, read the depth of snow on the outer site of the tube.
5. Turn tube at least one turn to cut the core loose. Carefully raise the tube, look through slots and check that the snow core is intact, read length of snow core (core length should be at least 90 percent of the snow depth except in snow of very low density or mushy snow. If it is not, retake.)

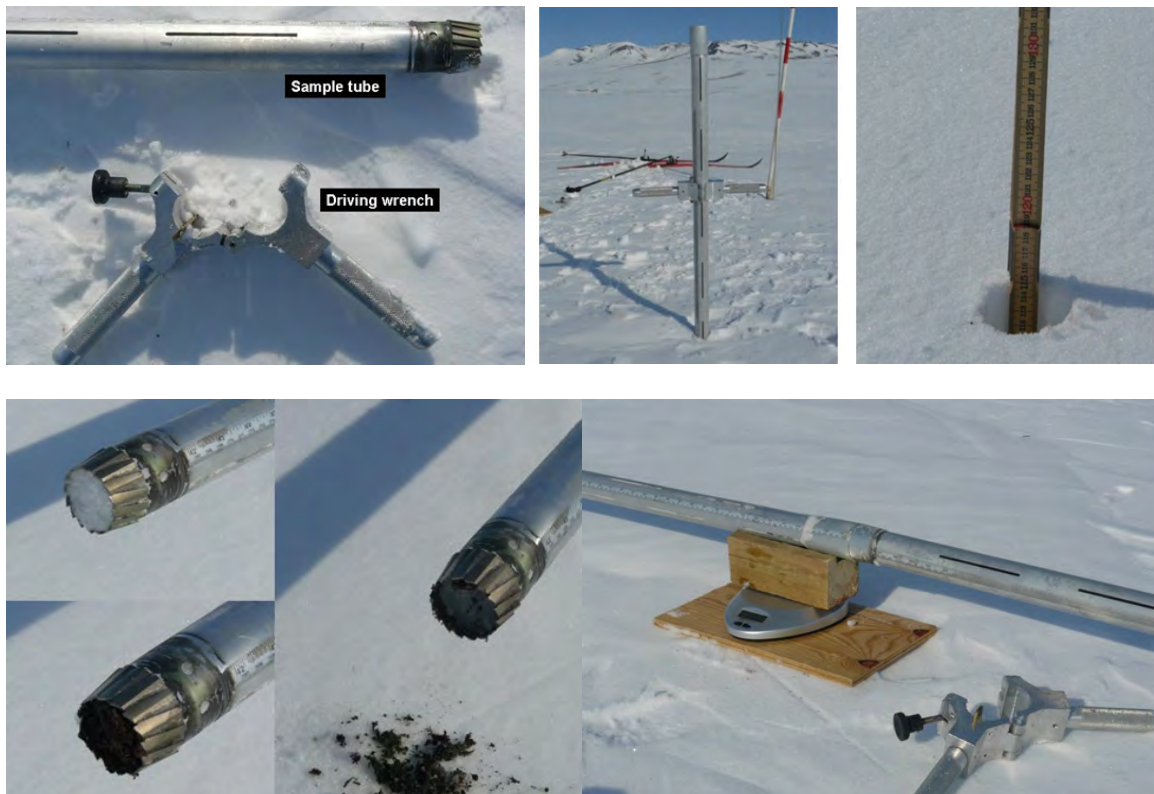

Figure 20: Snow sampling tube in use.

6. Use a folding rule to measure exact depth of snow where the sample was collected. Insert the folding rule in the hole and read cm at the snow surface (fig. 18).
7. Carefully, remove the driving wrench from the tube (makes it easier to weigh the tube and to clean it).
8. Inspect cutter end of tube for dirt or litter. Use a knife/multi-tool to carefully remove soil and litter from the cutter and tube. Correct the reading for snow depth and core length

by subtracting the distance driven into soil or litter.

9. Carefully balance the sampling tube containing the core on the weighing cradle or on a scale (fig. 20). If windy, point the tube into the wind. Record the weight in the field chart. If the total snow depth is below 1 m, the snow can be transferred from the tube to a pre-weighed plastic bag and measured more accurately. If it is windy or too cold for the scale to work outside consider to bring samples into the station in labelled plastic bags and weigh inside.

10. Remove the snow core from the tube by tapping the tube against the wooden plate. Weigh the empty sampling tube.

11. For each site, at least 3 cores must be taken.

### **3.5.3 Input of data into the local database**

Data are saved in the directory (GeoBasis\_YYYY/Snow monitoring/Snow density).

### **3.5.4 Maintenance**

Keep the sampling tubes clean and covered inside with a thin coating of spray silicone or wax. A well silicined or waxed tube helps in removing the snow core and the tubes screw together without binding.

### **3.5.5 Troubleshooting**

If snow melts and re-freezes inside the tube, it is probably because the tube is warm compared to the snow. Leave the tube in the shade or bury it in the snow. Another way to avoid this problem could be to take samples early in the morning or late in the evening when it is colder.

## **3.6 Snow cover and snow depletion**

Digital images of the main study area in Zackenberg dalen are used to monitor spatial and temporal snow cover distribution and to model depletion curves for snow in the valley. Images of the fiord Young Sound are used to study ice coverage and sediment plumes in the fiord. Snow depletion curves are computed from automatic digital photos taken daily from Nansen (see chapter 4). These photos are supported by manual photos of the valley taken frequently.

### 3.6.1 Manual snow cover monitoring

Digital images of the main study area in the Zackenberg valley are captured manually to ensure high resolution photos on certain days during the snow melt period.

#### Location

Photos are captured from the top of Nansenblokken on the east slope of Zackenberg fjeldet, where the automatic snow cameras are also mounted.

UTM: 509955 m E, 8265619 m N.

Elevation: 480 m a.s.l.

#### Frequency

On days with fine weather (no clouds or fog in the photo area) around 1 June, 10 June, 20 June and 30 June, respectively. On sunny days, photos must be taken in the afternoon (after 16:00) to prevent direct sunlight into the camera. It takes about 1-2 hours to walk from the station to Nansenblokken.

#### Equipment to be used

- Digital camera with calibrated lens (see chapter 4)
1. Take three photos of the valley (see Fig. 21). Keep the mountains in the horizon in the absolute uppermost part of the photo.
  2. Repeat the process with zoom and cover the same area. To be able to stitch the photos make sure the overlap between photos is large enough (c. 1/5).
  3. Take zoom images covering the river.
  4. Turn the camera 90° and repeat the zoom panorama with camera in a portrait position.
  5. Take zoom images of the Climate station, MM1, AC and MM2.

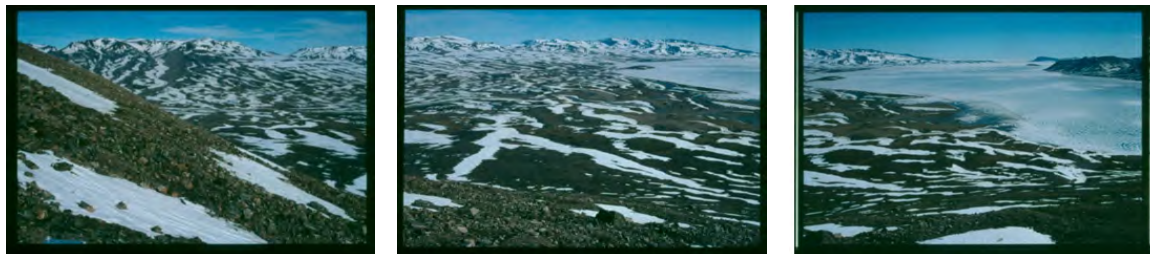



Figure 21: Monitoring photos. Three photos cover the central part of the valley and Young Sound.

### **3.6.2 Input of data into local data base**

Save the images in the GeoBasis directory (GeoBasis\_YYYY/Automatic Photo monitoring/StitchPhotos/Site/YYYY-mm-dd). Stitch the images using 'Image Composite Editor' and save the panorama as SITE\_YYYY-mm-dd.jpg in GeoBasis\_YYYY/Automatic Photomonitoring/StitchPhotos).

## 4 Automatic digital camera monitoring

### 4.1 Introduction

Automated time lapse cameras are mounted on the slope of the Zackenberg mountain and cover approximately 30 km<sup>2</sup> of the valley.

Data from the cameras are mainly used to analyze snow cover dynamics (including spatial distribution and timing of snow fall/snow melt) and phenology (periodic life cycles in biological systems), measured as vegetation greenness. Moreover, the images have been used to estimate ice cover extent on the fiord and sea, to perform surface classifications at high spatial resolution, and for general monitoring of the research sites. The time series of image data and the quality of single images are therefore of great importance to a number of different studies. Fig. 23 shows the resulting snow depletion curves and NDVI curves.

An automatic camera is also installed in proximity to a glacier dammed lake by A. P. Olsen land. The images from this camera are mainly used as supporting documentation of surges in the Zackenberg River.

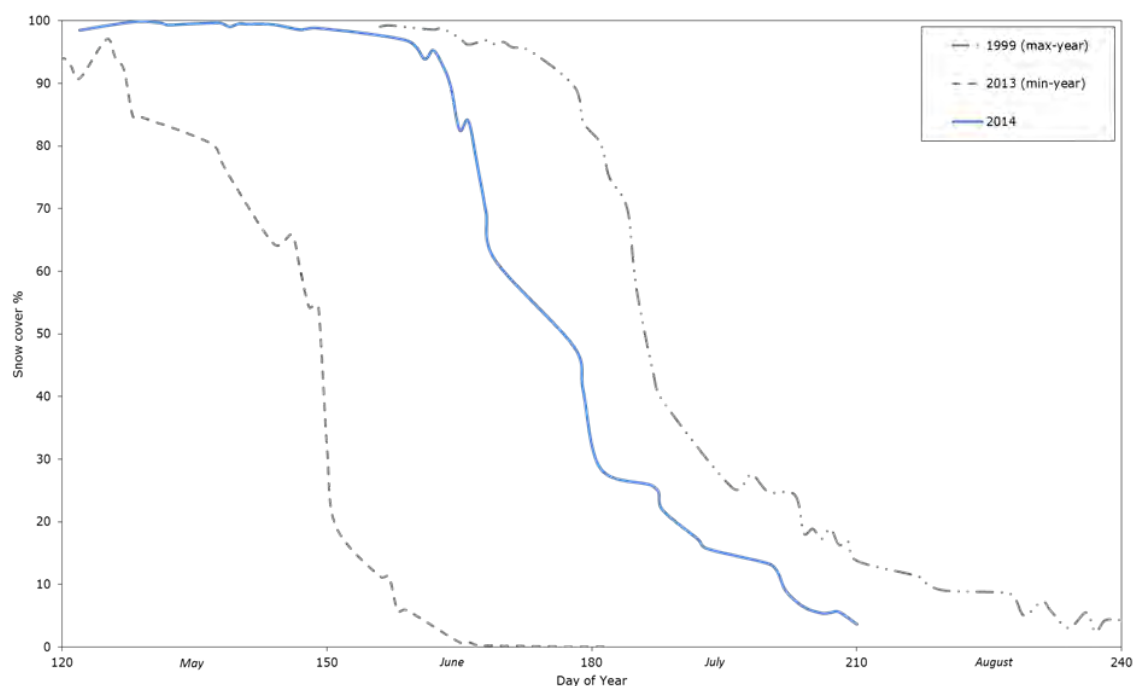

Figure 22: Snow depletion curves for the Zackenberg valley in 2014 (blue line), 1999 (year with latest snow melt) and 2013 (year with earliest snow melt).

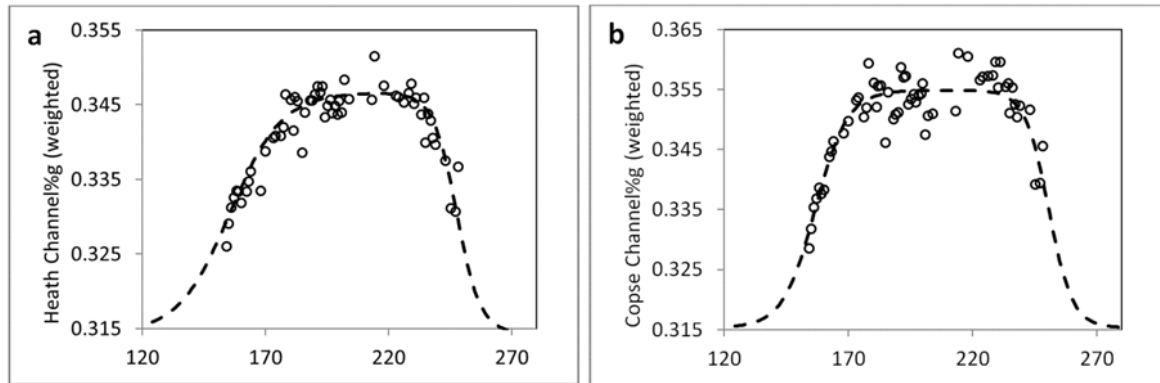

Figure 23: Vegetation greenness computed as a function of Day of Year. Start of growing season, seasonal peak, and senescence can be derived from the temporal evolution of the annual growing season greenness. Long term changes in growing season length or transition dates can thus be derived from the image data. Fig. a covers the heath and Fig. b covers the cope.

## 4.2 Automatic snow and ice cover monitoring

Digital cameras in waterproof boxes are mounted on a permanent platform where each camera box is secured in a fixed position and orientation (Fig. 24).

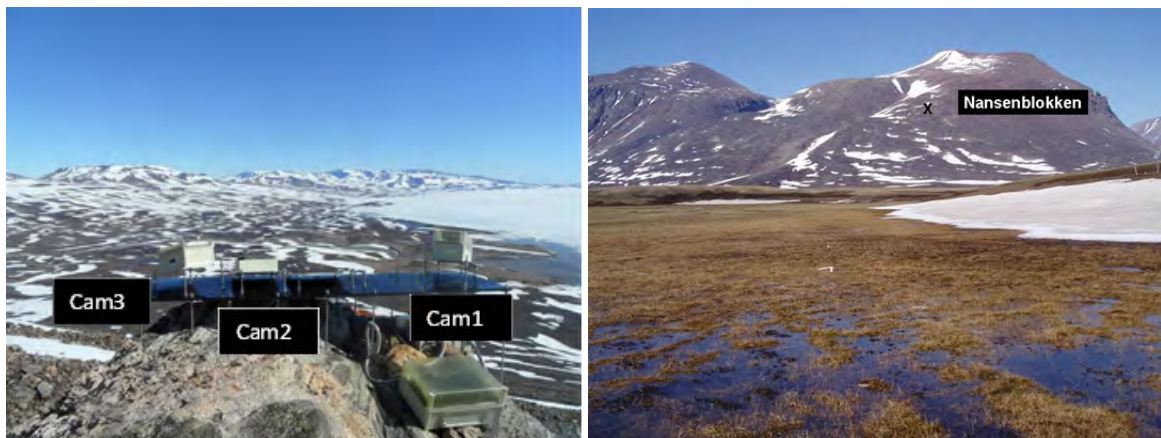

Figure 24: The fixed installation on top of Nansenblokken 480 m a.s.l. (left). Position of Nansenblokken on the eastern slope of Zackenberg (right).

### Location

Digital images are captured from the top of Nansenblokken, a prominent rock on the eastern slope of Zackenberg (Fig. 24).

UTM: 509954 mE, 8265615 mN.

Elevation: 480 m a.s.l.

### **Frequency of sampling**

Digital photos are captured every day at 13:20 (solar noon). Data are offloaded from the cameras soon after arrival to Zackenberg and frequently during the season (-see field programme).

### **Equipment to be used**

- Laptop computer with USB-reader and adapter for reading Eye-Fi SD-memory cards
- Voltage meter
- Screwdriver
- Watch
- User manual for each camera (digital copy on the computer)
- Spare 12 V battery
- Silica bags
- There is a spare box on Nansenblokken where tools or batteries and a copy of the manuals can be left

### **Camera 1**

Covers the southern part of the valley and Young Sound.

Camera: Canon EOS 1000D

Camera has operated since: 2016

Memory card: 32 GB Eye-Fi Secure Digital card

Logging time: UTC+0

Battery (Inside box): 12 V, 7 Ah

Charged by solar panels in the box cover

Photos from this position started: 1999



## Camera 2

Covers the main part of the study area in the valley.

Camera: Canon EOS 1000D

Camera has operated since: 2013

Memory card: 32 GB Eye-Fi Secure Digital card

Logging time: UTC+0

Battery: 12V, 7 Ah

Charged by solar panels in the box cover

Photos from this position started: 1997

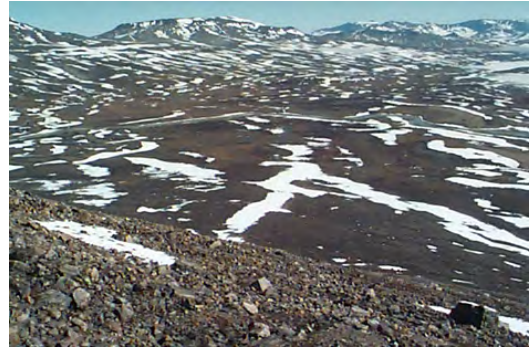

## Camera 3

Covers the northern part of the valley.

Camera: Canon EOS 1000D

Camera has operated since: 2016

Memory card: 32 GB Eye-Fi Secure Digital card

Logging time: UTC+0

Battery: 12V, 7 Ah

Charged by solar panels in the box cover

Photos from this position started: 2001



### 4.2.1 Offloading cameras

1. Open the camera box by undoing the four screws and carefully remove the lid (be aware of cables from the solar panel in the lid attached to the battery in the box).
2. Remember to always note voltage on the battery, time on the timer, actual time etc. in the field chart or diary.
3. Remove the SD card from the camera (Make sure not to eject it when the picture is taken) and copy all images to the computer hard disk. Images on the card should only be deleted if the remaining free space on the card is low.
4. Check that there is an image from each day and that they look all right (no major reflections or dirt in front of the lens).
5. Re-insert the card in the camera. Make sure that the orientation of the card is right. Press to ensure good connection.
6. Before you close the waterproof box make sure that: -the camera is OFF (dark display) -the timer is set to off and then auto using the Manual button to shuffle through the settings -there is a bag of desiccant (silica gel) in the box and -that the window in front of the lens



is clean.

#### **4.2.2 Camera settings**

Make sure the date and time on the camera is right. In case of power failure the camera may lose its internal data and time stamp and will give the photos the same default timestamp, that doesn't make sense.

#### **4.2.3 Timer settings**

The timers are programmed to start at 13:10 (Cam1), 13:20 (Cam2) and 13:30 (Cam3) and stay on for 5 minutes. For programming of the timer and to set the clock, please refer to the timer manual.

#### **4.2.4 Input of data into the local database**

Save photos in the GeoBasis directory GeoBasis\_YYYY/Automatic photomonitoring/CamX/. Copy photos from each camera to the GeoBasis directory GeoBasis/Automatic photomonitoring/CamX/CamX YYYY/ and rename them after the system: CAMXYEARXXXXDOY-XXX (ex. CAM1YEAR2002DOY155 picture from camera 1 taken on the 4th of June 2002). Use rename software for this process (Rename wizard or Rename master). Always keep a backup of the raw data with original filenames.

#### **4.2.5 image analysis**

Images are used to compute snow cover fractions for different regions in the valley – separate manual by Andreas Westergaard-Nielsen og Line Vinther Hansen.

#### **4.2.6 Maintenance**

- 12 V batteries inside the camera box must be replaced every year.
- Check plastic/glass in front of the lens and clean or change if necessary.
- Change the box lid if the plastic becomes unclear/less transparent as the effect of the solar panel on the inside of the lid will be reduced.

#### **4.2.7 Trouble shooting**

- Always check the power supply if cameras have stopped taking photos.



Figure 25: The camera position is marked on the map by the green triangle (left). The block with the camera on top (right).

- Make sure the timer and the camera has the right date and time settings, otherwise photos will not be captured.
- Check that the memory card has enough free space.
- Consult the User Guide for camera and timer.
- If problems cannot be solved in the field, undo the box and bring the camera box to the station.
- In case one of the cameras at Nansenblokken break down, then replace it by one of the spare cameras at the station.

### 4.3 Automatic camera at glacier lake

An automatic camera is placed at a glacier dammed lake at A.P. Olsen land (see Fig. 25) in order to follow the dynamics of this lake and the glacier front. At several occasions draining of this lake has caused large floodings in the Zackenberg River.

#### Location

The camera is placed on a big rock on the NW-side of the glacier-dammed lake UTM: 82844,66 mN, 487814,75 mE, Elevation: 755 m a.s.l.

#### Frequency

The camera is placed almost 40 km from the Research Station and must be off loaded in the early season when there is enough snow to reach the glacier by snow mobile.

#### Equipment to be used

- Spare camera and box (in case the old one is broken or flooded)
- Equipment to mount the camera box
- Spare SD-card
- Voltage meter
- Laptop computer and SD card reader
- 12 new AA batteries

## Camera 6

Covers part of the glacier dammed lake and the glacier front.

Camera: Reconyx PC800

Camera has operated since: 2015

Memory card: 2 GB Secure Digital card

Logging time: UTC+0

Battery: 12 AA batteries

Reconyx PC800 Professional manual

Photos from this position started: 2008



### 4.3.1 Offloading the camera

See procedure from section 4.2.1.

### 4.3.2 Camera settings

Make sure the date and time on the camera is right. In case of power failure the camera may lose its internal date and time and will not be able to take photos.

The timer is programmed to turn the camera on: 14:30 and switch the camera off at 14:31. Always make sure that auto focus is disabled, the flash light is disabled or the flash covered.

### 4.3.3 Input of data into the local database

See section 4.2.4 (GeoBasis\_YYYY/Automatic photomonitoring/Cam6\_Glacier).

### 4.3.4 Manual photomonitoring of Glacier dam

When visiting the Glacier lake camera, remember to take a photo overlooking the glacier front towards the south see Fig. 26.



Figure 26: Manual photo monitoring of the glacier dam. Photo taken on the 6th of May 2010.

#### 4.4 Calibration of camera lens

All cameras used to capture photos from Nansenblokken must have the lens calibrated. In Zackenberg there is a calibration chart in House 4.

##### Calibrating a camera lens

1. You need a large flat clean floor. The floor in House 1 (canteen) is well suited for this purpose.
2. Mount the Calibration chart on the floor and make sure you have 1-2 m at each side of it.
3. Take a normal landscape photo (no zoom) of the calibration chart from one of the sides. Make sure you have all dots in the photo and that they fill out most of the photo.
4. Move to side 2 (Fig. 27) and take a photo of all the dots from this position. Repeat the same process from side 3 and 4.
5. Move to side 1. Turn the camera to a portrait position ( $90^\circ$  to the left) and take a photo that captures all dots (now you need more distance to the chart in order to still cover all dots in a photo).
6. Repeat the portrait photos from side 2, 3 and 4.
7. Turn the camera  $180^\circ$  (upside down) and take a photo from side 1 that captures all dots. Repeat from side 2, 3 and 4.
8. Now you have all together 12 photos. Save them in the GeoBasis directory: (GeoBasis/Automatic Photomonitoring/Camera calibration) Include a “read me”-file with information about the type of camera.

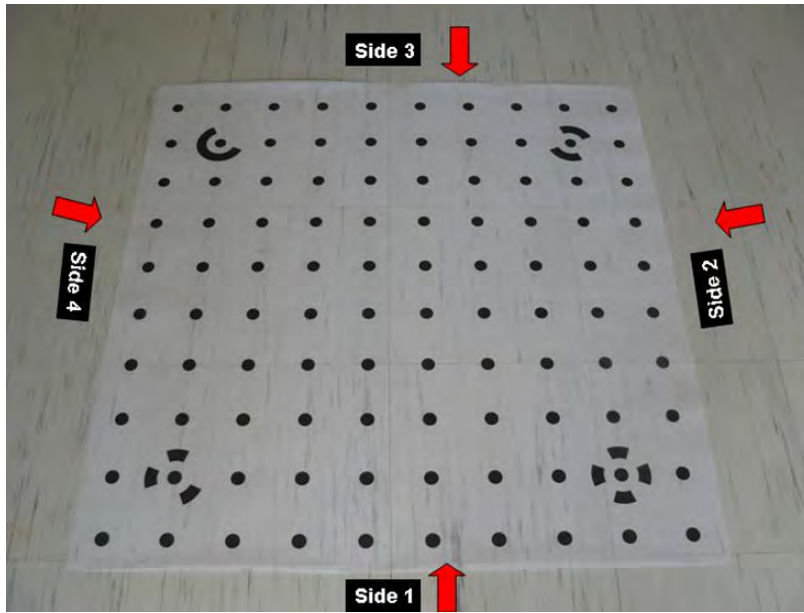

Camera position

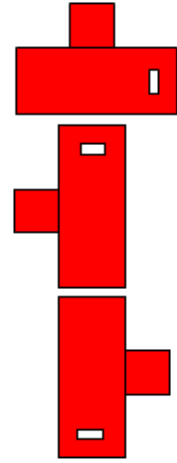

Figure 27: Calibration chart on the floor in House 1.

## 5 Soil thaw and development of active layer

### 5.1 Introduction

The active layer is the zone of annual thawing and freezing in areas underlain by permafrost, i.e. the upper part of the soils of Zackenberg. This zone is the center for many important and dynamic processes, including biologic, geomorphologic, hydrologic and biogeochemical. Thickness of the active layer and rate of thaw varies from year to year, depending on factors such as ambient air temperature, vegetation, soil type, water content, snow cover, slope and aspect. Changes in the active layer depth can result in substantial ecological and terrain disturbances; including soil subsidence and changes in soil moisture content, surface energy balance and soil organic carbon availability. Measurements of the inter-annual variation in seasonal thawing and freezing are important in order to understand and model the response of permafrost soils to climate change.

In Zackenberg, measurements of the active layer depth are performed on a bi-weekly basis from the time of snow melt until annual freeze-up at two sites; ZEROCALM-1 and ZEROCALM-2. Both sites are a part of the Circumpolar Active Layer Monitoring Network (CALM). The primary goal of the CALM program is to observe the response of the active layer and the near surface permafrost to climate change over multi-decadal time scales.

The progression of active layer depth for three years in ZEROCALM-1 is shown in Fig. 28. Minimum thaw depths were recorded in 1999, whereas maximum thaw depths were measured in 2009 and 2013. Seen over the whole monitoring period in Zackenberg, the maximum thaw depths have increase in both ZEROCALM-1 and ZEROCALM-2 (Fig. 29).

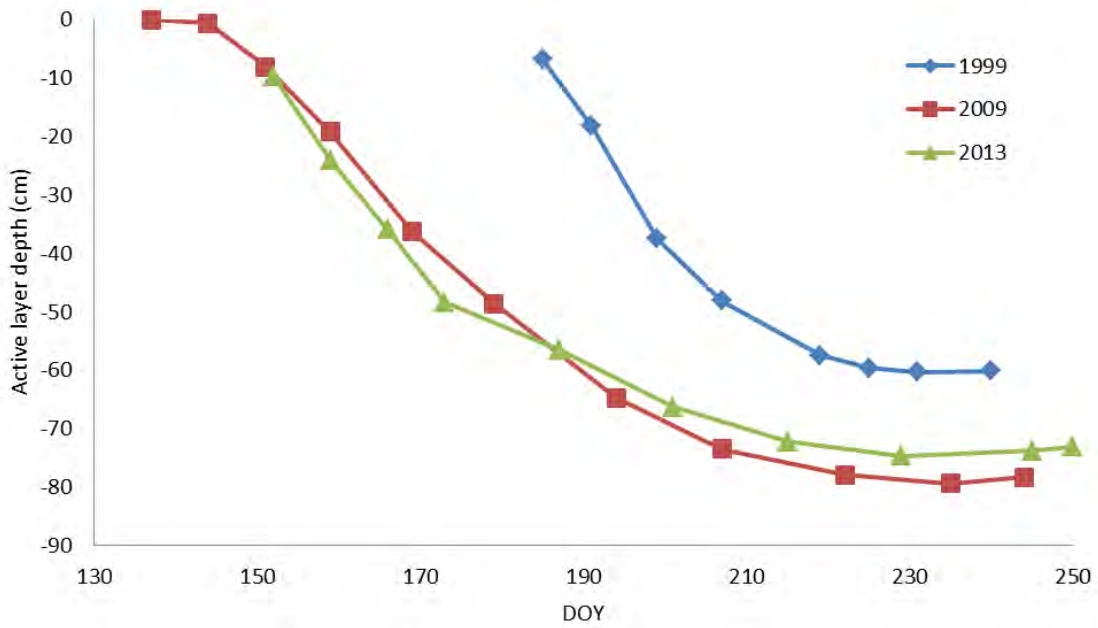

Figure 28: Thaw depth progression in ZEROCALM-1 in 1999, 2009 and 2013.

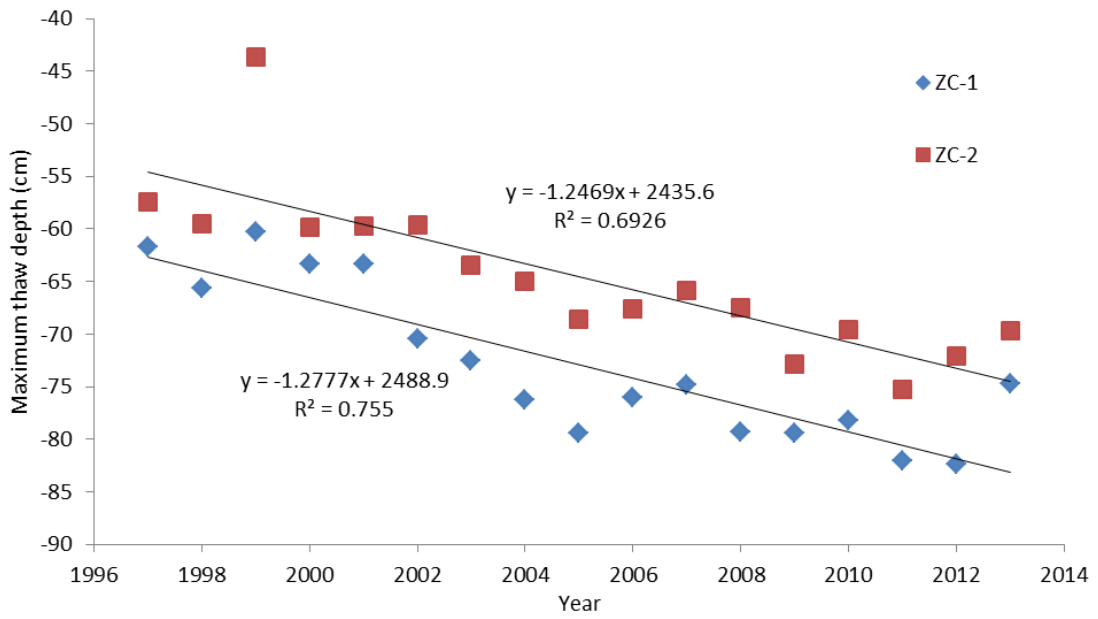

Figure 29: Maximum thaw depths recorded in ZEROCALM-1 (ZC-1) and ZEROCALM-2 (ZC-2) during the period 1999-2013.

## **Location**

### **ZEROCALM-1 (ZC-1)**

Located right north of the climate station on a horizontal and well-drained Cassiope heath. The site consist of 121 measuring points in a 100 m x 100 m grid (11 almost N-S oriented rows each with 11 points). There are 10 m between every point. Every corner of the grid is marked by orange traffic poles. Points along the edge of the grid are marked by orange stones while all other points are marked by white stones.

UTM:

NW-corner: 8264856 mN, 513363 mE

NE-corner: 8264847 mN, 513461 mE

SW-corner: 8264758 mN, 513347 mE

SE-corner: 8264748 mN, 513446 mE

Elevation: 45 m a.s.l.

Established: 1996

### **ZEROCALM-2 (ZC-2)**

Located c. 400 m south of the runway on a south facing slope at an elevation of 11-22 m a.s.l. Vegetation change from dry dryas heath at the upper end to a waterlogged Eriophorum fen in the lower end. The site consist of 208 measuring points in a 120 m x 150 m grid (16 almost N-S oriented rows each with 13 points). There are 10 m between every point. Every corner of the grid is marked by poles. Points along the edge of the grid are marked by orange stones while all other points are marked by white stones.

UTM:

NW-corner: 8264083 mN, 513025 mE

NE-corner: 8264033 mN, 513167 mE

SW-corner: 8263970 mN, 512985 mE

SE-corner: 8263920 mN, 513127 mE

Elevation: 11-22 m a.s.l.

Established: 1996





Figure 30: Location of the two ZEROCALM sites ZC-1 and ZC-2 (left). Photo monitoring point at ZC-2. Looking at ZC-2 and M2 from the south east corner of the grid (right).

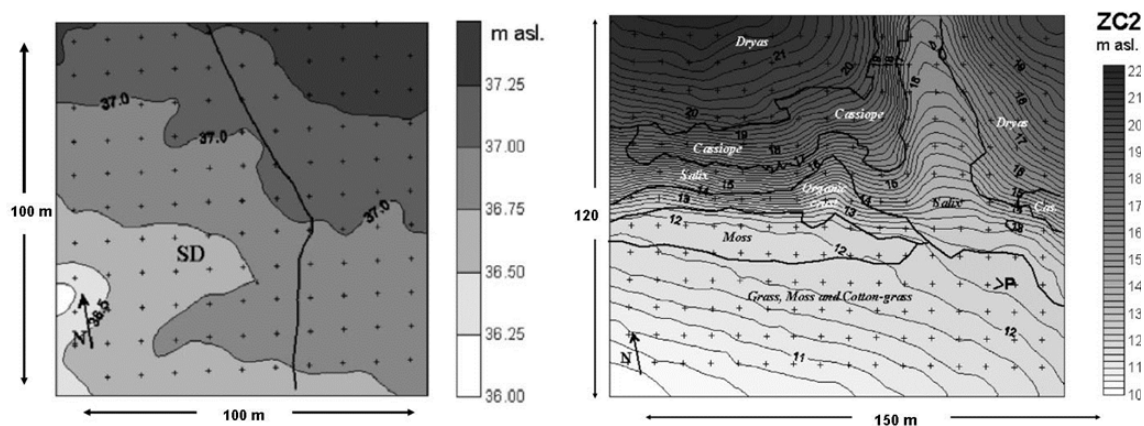

Figure 31: Surface topography/elevation at the two CALM-sites and borders between main vegetation communities in ZC-2.

### Frequency

Measurements are made as soon as one point in the grid is free of snow. Repeat measurements on a weekly basis until snow has disappeared in ZC-1 and only the snow fan on the south facing slope is left in ZC-2. Thereafter the active layer is measured once every second week until the upper part of the soil starts to freeze.

### Equipment to be used

- Stainless steel rod/probe with centimetre graduation and handle (1.2 m long)
- Field chart 4 and 5, H
- Digital camera

## 5.2 Procedure for active layer measurements

1. Start in one of the corners in the grid. Make sure that the orientation of the field chart is right compared to the grid. Measurements have been performed since 1996 and several times each year which means there are a large number of probe holes around the grid mark. At the first probing each year decide where you will probe this season, and use the same hole throughout the rest of the season. Note: in 2018 all probing should be approx. 20 cm NORTH of the stones (in 2019 EAST of the stones).

2. Press the steel rod vertically down in the ground. When the tip of the rod touches the frozen surface, a finger is placed on the rod at the soil surface. Pull up the rod and read the depth on the centimetre division. Make sure you do not force the probe to deep. Stop pressing when you feel resistance.

3. Note the depth in the field chart. It is important that all measurements are made to the soil surface and not the vegetation surface. Especially, in the wet part of ZC-2, where the water level is high and the vegetation is dense it can be difficult to determine the soil surface. Press your fingers all the way down along the rod until you feel resistance.

4. Take digital photos from the south east-corner of the ZC-2 grid in order to cover the snow patch and the east facing slope of Zackenberg (Fig. 32) and take a photo where you zoom in on the automatic weather station M2.



Figure 32: Stitch photo from ZC-2 (13 June 2005).

### 5.2.1 Maintenance

Birds and musk oxen are able to move the stones. Make sure that stones are in the right positions and if necessary, re-establish the grid.

### 5.2.2 Input of data into the local database

Write values from the field chart into a worksheet. Grid nodes are numbered 1–121 and 1–208 beginning in the northwest corner and reading down the rows as you would read text.

Thus, the last node 121 or 208 is in the southeast corner. Name the file: ZC1 (or 2)\_yyyy and save the data in file in the GeoBasis directory: (GeoBasis\_YYYY/ZEROCALM/ZC/textendash1 or ZC/textendash2/Active layer).

### ZEROCALM-1

	NW										
11	1	2	3	4	5	6	7	8	9	10	11
10	12	13	14	15	16	17	18	19	20	21	22
9	23	24	25	26	27	28	29	30	31	32	33
8	34	35	36	37	38	39	40	41	42	43	44
7	45	46	47	48	49	50	51	52	53	54	55
6	56	57	58	59	60	61	62	63	64	65	66
5	67	68	69	70	71	72	73	74	75	76	77
4	78	79	80	81	82	83	84	85	86	87	88
3	89	90	91	92	93	94	95	96	97	98	99
2	100	101	102	103	104	105	106	107	108	109	110
1	111	112	113	114	115	116	117	118	119	120	121
Y/X	1	2	3	4	5	6	7	8	9	10	11
	SW										

### ZEROCALM-2

	NW															
13	1	2	3	4	5	6	7	8	9	10	11	12	13	14	15	16
12	17	18	19	20	21	22	23	24	25	26	27	28	29	30	31	32
11	33	34	35	36	37	38	39	40	41	42	43	44	45	46	47	48
10	49	50	51	52	53	54	55	56	57	58	59	60	61	62	63	64
9	65	66	67	68	69	70	71	72	73	74	75	76	77	78	79	80
8	81	82	83	84	85	86	87	88	89	90	91	92	93	94	95	96
7	97	98	99	100	101	102	103	104	105	106	107	108	109	110	111	112
6	113	114	115	116	117	118	119	120	121	122	123	124	125	126	127	128
5	129	130	131	132	133	134	135	136	137	138	139	140	141	142	143	144
4	145	146	147	148	149	150	151	152	153	154	155	156	157	158	159	160
3	161	162	163	164	165	166	167	168	169	170	171	172	173	174	175	176
2	177	178	179	180	181	182	183	184	185	186	187	188	189	190	191	192
1	193	194	195	196	197	198	199	200	201	202	203	204	205	206	207	208
Y/X	1	2	3	4	5	6	7	8	9	10	11	12	13	14	15	16
	SW															

### 5.2.3 Quick validation

Check that there is consistency for each point and that the active layer increases or stays the same during the summer. Decrease of depth is only possible when freeze back of the active layer starts. A sudden lower active layer depth could mean that you hit a stone. If the measurement is not performed at the exact same spot every time the surface topography can cause some variation in depth. Finally, this method is not always useful in very dry soil where it is possible to work the steel probe through the upper part of the permafrost.

### 5.2.4 Input of data into international database

By the end of the season data are reported to CALM (Circumpolar Active Layer Monitoring) programme under ITEX (International Tundra Experiment) and IPA (International Permafrost Association). Send the data in Excel worksheet to: strelets@gwu.edu for archiving. Homepage for CALM: [www.gwu.edu/~calm](http://www.gwu.edu/~calm)

**Contact CALM III (2009-2014):**

Nikolay I. Shiklomanov  
Department of Geography  
University of Delaware  
Newark, DE  
USA 19716  
Shiklom@udel.edu

**Contact for input to CALM database**

Dimitry A. Streletskiy  
Assistant professor  
Geography Department  
George Washington University  
1922 F St., N.W. #217  
Washington, DC 20052  
strelets@gwu.edu

## 6 Temperature in snow, ground, air and water

### 6.1 Introduction

Within the GeoBasis program an extensive network of temperature loggers have been installed in various locations throughout the Zackenberg valley. Temperature is monitored in snow, air and water, but the primary focus is on soil temperatures under different vegetation types and in different depths, including the permafrost.

Both daily, seasonal and inter annual variation in ground temperatures is important for active layer development, phenology, the energy balance and consequently the soil-atmosphere exchange of natural greenhouse gasses like carbon dioxide, methane and nitrous oxide.

The monitoring of both above and below ground temperatures is carried out using several methods; TinyTag loggers, different thermocouples connected to Campbell Scientific CR1000 data loggers and GeoPrecision temperature strings. The deepest of which is recording the ground temperature in 18.75 m depth. Below are shown examples of typical seasonal patterns in soil temperatures beneath two common landscape types in the Zackenberg valley: dry heath and wet fen (Fig. 33). The different thermal regime between a well-drained heath and a wet fen, A and B respectively, is especially apparent immediately after the snow melt period, where the temperature increase in the heath is much more gradual compared to the fen.

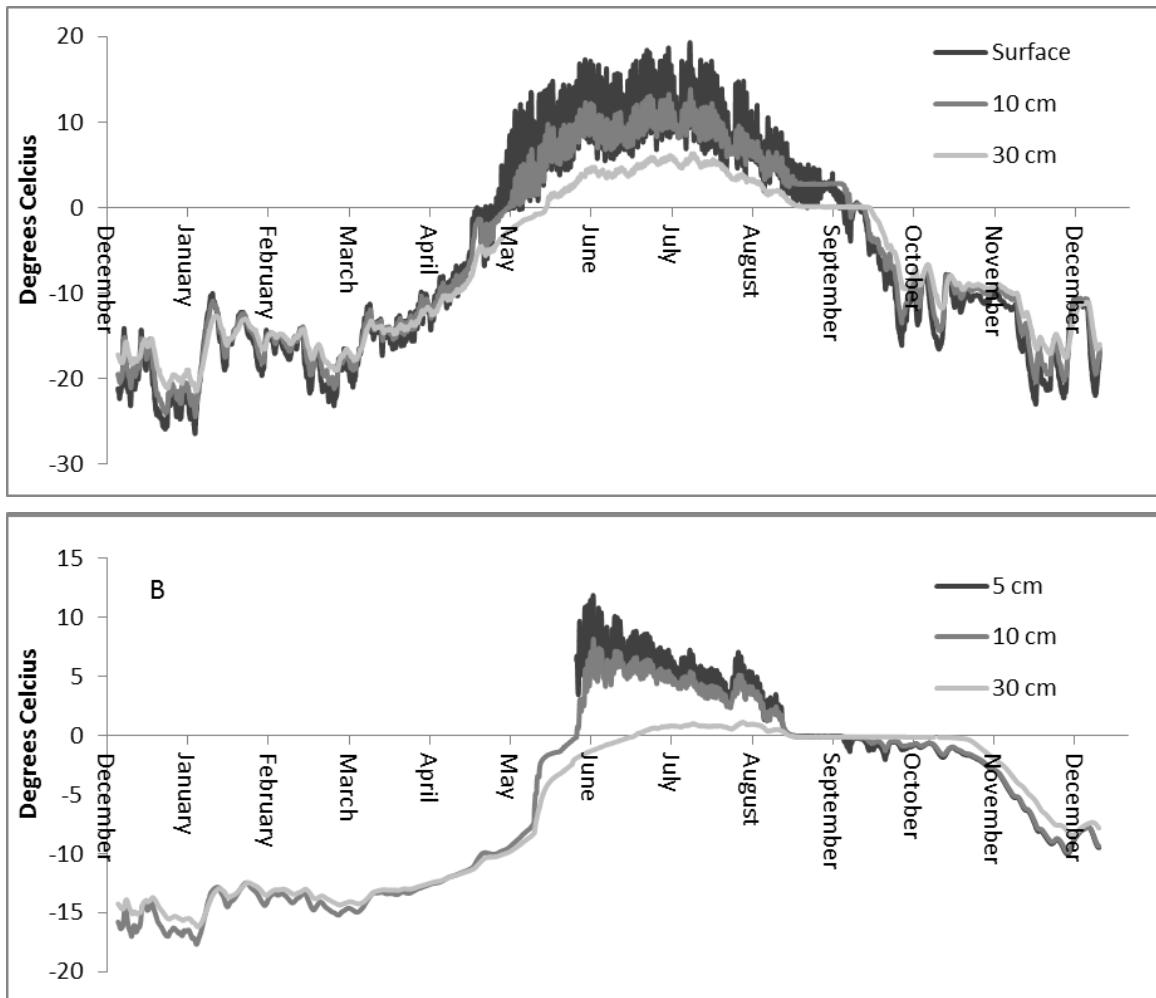

Figure 33: Seasonal variation from 2011 in soil temperatures under A) dry heath vegetation, dominated by *Dryas integrifolia/octopetala* and B) wet continuous fen, dominated by sedges. Notice different Y-axis.

## 6.2 TinyTag data loggers

Temperature is monitored at various locations at different elevations within the study area (Fig. 34). Small data loggers are placed in geomorphologic settings of interest such as ponds, snow patches and in the ground. Vertical temperature profiles within the active layer describe the temperature regime in different soil types for different places in the Zackenberg Valley. At various sites the air temperature near terrain is monitored as well.

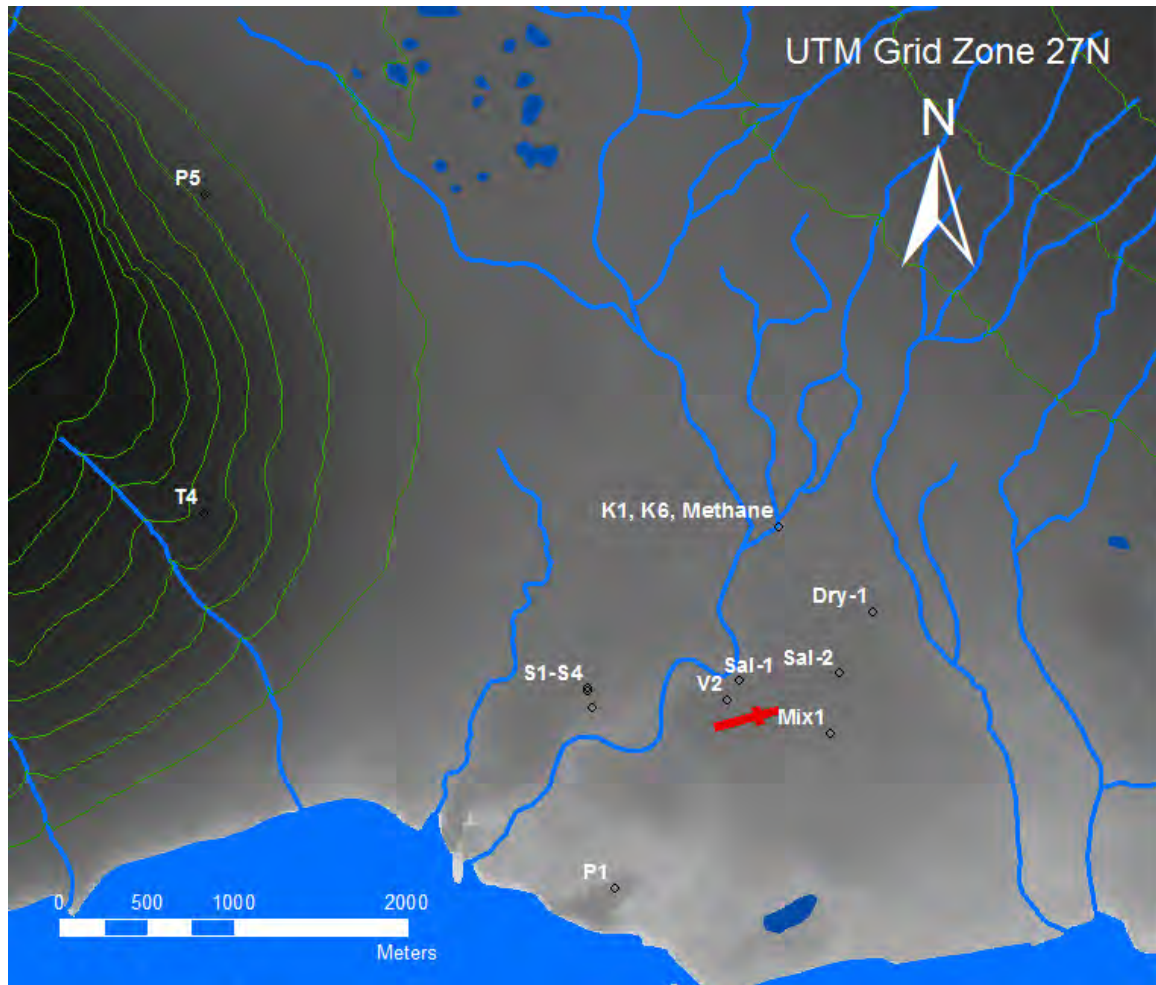

Figure 34: Map of tinytag logger locations in the Zackenberg valley.

### **P1**

Eastern part of a gravel plateau south of the Zackenberg station. Close to the coast south of the old delta and east of the Zackenberg river mouth. P1 is located c. 20 m west of an ice wedge site.

Subject: Active layer temperature.

UTM: 512321 m E, 8263455 m N

Elevation: 20 m a.s.l.

Logging time: UTC+0

Installation depth: 0, 10, 50, 118 cm

Operation period: 1995-

New installation: 2005



### **P5**

On the top of a rock glacier at the northeast foot of Zackenberg. The front of the rock glacier is about 25 m high. Walk up the talus slope south east of the rock glacier and continue on top of the rock glacier in a northwest direction. About 25 m southwest of the front the site is marked by a pink triangle on a big boulder. Tinytags are found c. 3 m north of this boulder.

Note: The easiest way to find the site is from the south. Use the GPS and climb to the approximate elevation, then go north until you meet the clearly marked stones with red paint.

Subject: Active layer temperature in very coarse clastic sediment.

UTM: 501002 m E, 8267463 m N

Elevation: 259 m a.s.l.

Logging time: UTC+0

Installation depth: 0, 75, 135 cm

Operation period: 1996-





#### **T4**

On Nansenblokken at the eastern slope of Zackenberg. The TinyTag is located in a stone cairn next to the digital cameras.

Subject: Air temperature.

UTM: 509954 mE, 8265615 mN

Elevation: 480 m a.s.l.

Logging time: UTC+0

Operation period: 2002-

Should be terminated during the 2018 season.



#### **V2**

On the southern side of “Gadekæret” north-east of house number 6.

Subject: Water temperature at the bottom of a pond.

UTM: 512988 mE, 8264522 mN

Elevation: 35 m a.s.l.

Logging time: UTC+0

One TinyTag

Installation: Under fluctuating water levels.

Operation period: 1995-



### S1-S4

Traverse through the big snow patch west of the Zackenberg river c. 250 m southwest of the river crossing.

Subject: Soil surface temperatures inside and around a large snow patch.

UTM: 512209 mE, 8264467 mN

Elevation: 16-29 m a.s.l.

Logging time: UTC+0

Installation: One tinytag on the plateau north of the snow patch (S1). Two tinytags on the south facing slope within the snow patch; S2 in the upper end and S3 in the lower end. One TinyTag in front of the slope in the vegetation c. 10 m south of the stream that drains the snow patch (S4).

Operation period: 1995-

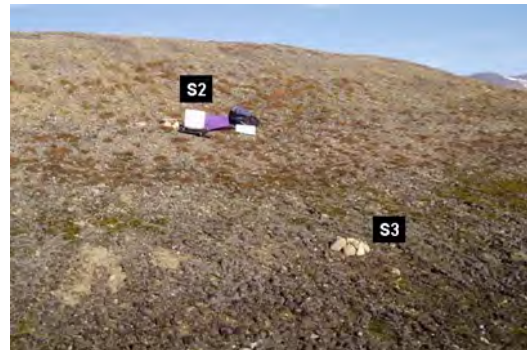

### Sal-1

Adjacent to the BioBasis plot "Sal-1".

The TinyTags are placed inside a waterproof box mounted on steel legs.

Subject: Active layer temperature.

UTM: 8264649 mN, 513045 mE

Elevation: 34 m a.s.l.

Logging time: UTC+0

Installation depth: 0, 15 cm Operation period: 2002-2006

Re-installed in 2007 at 0, 10, 30 cm

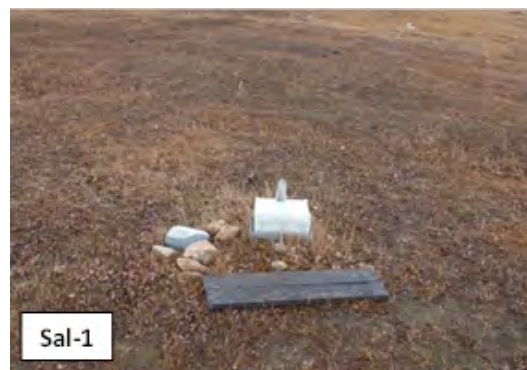

### Sal-2

Adjacent to the BioBasis plot “Sal-6”.

The TinyTags are placed inside a waterproof box mounted on steel legs.

Subject: Active layer temperature.

UTM: 8264692 mN, 513723 mE

Elevation: 40 m a.s.l.

Logging time: UTC+0

Installation depth: 0, 10, 30 cm

Operation period: 2003-

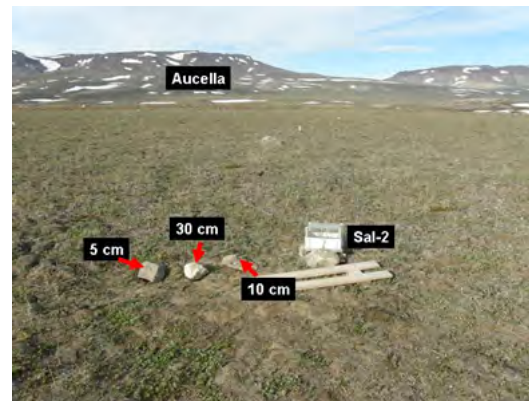

### Dry-1

Adjacent to the BioBasis plot “Dry-3”.

The TinyTags are placed inside a waterproof box mounted on steel legs.

Subject: Active layer temperature.

UTM: 8265045 mN, 513816 mE

Elevation: XX

Logging time: UTC+0

Installation depth: 0, 10, 30 cm

Operation period: 2003-

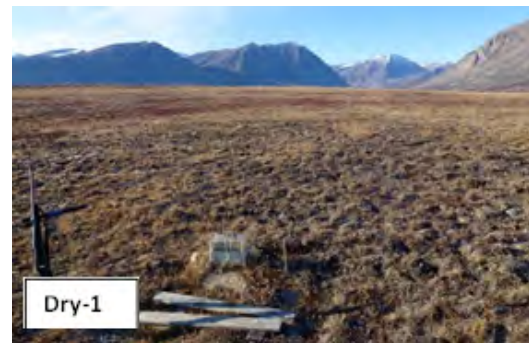

### Mix-1

Adjacent to the BioBasis phenology plot Pap-3.

The TinyTags are placed inside a waterproof box mounted on steel legs.

Subject: Active layer temperature.

UTM: 8264348 mN, 513567 mE

Elevation: 35 m a.s.l.

Logging time: UTC+0

Installation depth: 0, 10, 30 cm (30 cm was cut by foxes in 2006 and has not been replaced)

Operation period: 2004-

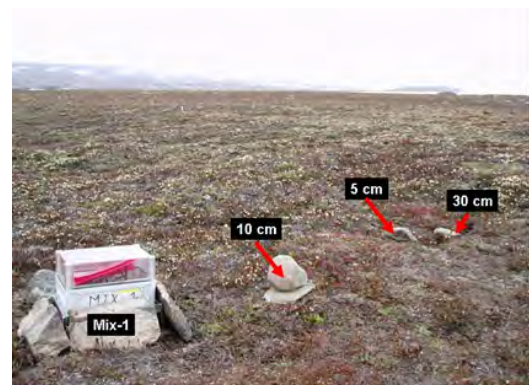

**K1**

Adjacent to the automatic chamber nr. 1.

The TinyTags are placed inside a waterproof box mounted on steel legs. When the box melts free of snow the logger should be offloaded, batteries changed and the logging interval changed to every 5 minutes.

Subject: Active layer temperature.

UTM: 8265544 mN, 513271 mE

Elevation: 35 m a.s.l.

Logging time: UTC+0

Installation depth: 5, 10, 30 cm

Operation period: 2010 –

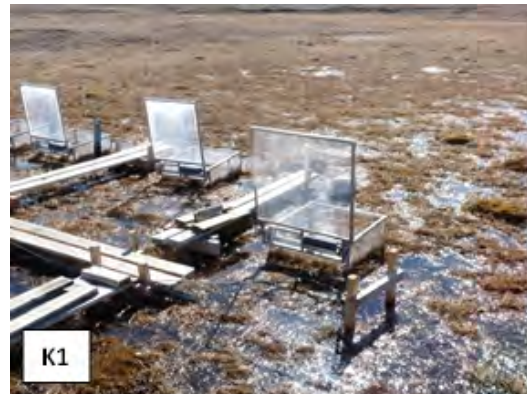

**K6** Adjacent to the automatic chamber nr. 6.

The TinyTags are placed inside a waterproof box mounted on steel legs. When the box melts free of snow the logger should be offloaded, batteries changed and the logging interval changed to every 5 minutes.

Subject: Active layer temperature.

UTM: 8265542 mN, 513277 mE

Elevation: 35 m a.s.l.

Logging time: UTC+0

Installation depth: 5, 10, 30 cm

Operation period: 2010 –

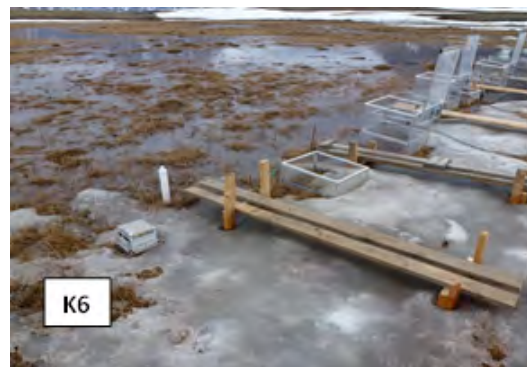

**Methane** Adjacent to the boardwalk between automatic chamber nr. 3 and 4.

The TinyTags are placed inside a waterproof box mounted on steel legs. When the box melts free of snow the logger should be offloaded, batteries changed and the logging interval changed to every 5 minutes.

Subject: Active layer temperature.

UTM: 8265545 mN, 513273 mE

Elevation: 35 m a.s.l.

Logging time: UTC+0

Installation depth: 5, 10, 15 cm

Operation period: 2007 –



### Frequency

As soon as the box is free of snow, it must be checked if the logger works. A single green light that flashes at steady intervals indicates that the TinyTag is still logging. All tiny tags except the ones at the automatic chamber site (see chapter 11) are recording the temperature every hour. At the automatic chamber site, the logging interval is every hour during winter, but every 5th minute during summer. Data is offloaded once a year, except for at the automatic chamber site, where data are offloaded as soon as possible after winter and once again before the station is left in the fall. Logging interval is set when offloading data. Batteries are changed every second year.

### Equipment to be used

- TinyTag Plus-data loggers
- Batteries (3.6V)
- Screw driver
- Laptop
- TinyTag Explorer software
- Software interface cable
- Small silica gel bags
- Extra O-rings

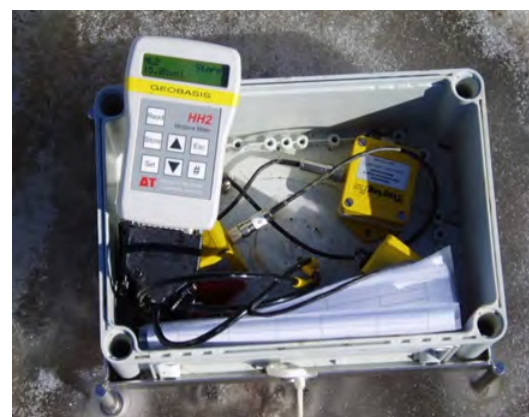

### 6.2.1 Offloading data from the TinyTags

If possible offload the TinyTags at the site and restart it right away. Always bring some loggers that are started if you need to change a logger, or if you run out of power on the computer. **Notice:** The data logger must be stopped before the readings are retrieved - otherwise the old data are left in the logger and the memory will not be able to keep another year of data.

1. Record the exact time of removal or offloading. If you need to disconnect the logger, make sure there is a label on the sensor cable indicating the installation depth and likewise on the logger.
2. Connect the TinyTag-logger to the parallel port on the computer by the TinyTag interface cable.
3. Open the Gemini software program “TinyTag Explorer”.

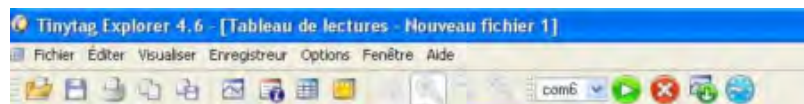

4. Press [stop the logger] on the menu. The red key with a cross.
5. To offload data from the logger press [Get data from the logger] (icon with downward pointing arrow). When all data are retrieved a temperature curve is displayed on the screen.
6. Save data in the directory: (GeoBasis\_YYYY/TinyTag/Original data). Name the file after the system: SS\_XXcm, where SS = site and XX= installation depth (ex. P6\_30cm is a file from P6 at 30 cm depth and keep the suggested file extension (.ttd).

### 6.2.2 Battery change

Batteries must be changed every second year if logging interval is every hour. **Notice:** Always offload the TinyTag data logger before removing the battery. See TinyTag logbook in the GeoBasis\_YYYY/TinyTag directory.

1. Open the TinyTag by undoing the four screws. Move the small foam pad and the silica gel. Remove the battery. Write the current year on the new battery with a speed marker -then you will always know when the battery was changed.
2. Install a new battery (with current year written on it)
3. Check that the black O-ring looks smooth. If not, rub it in silicon or replace it by a new ring from the maintenance-kit. Replace the small silicon bag and close the data logger tight.

### 6.2.3 Restart/launch data logger

1. Connect the logger to the computer. Press the green key with an arrow [Erase data, edit configuration and launch data logger]. A new window pops up.
2. Follow the instructions and choose the following settings:
  - Title (name of the site and depth),
  - Logging interval (every hour),
  - Start options (delayed start – nearest hour),
  - Stop options (stop when full),
  - Alarms (disabled).
3. Choose “Absolute start time” and specify the next whole hour (e.g. 14.00, 15.00 etc.). Make sure that the time on the computer is right and that the time in the software program is right. **Notice:** Standby mode of the computer can stop the clock in the TinyTag communication program.
4. Press [Launch] to program the settings into the logger.
5. Check the Launch confirmation box to see if the logger program is right.
6. Press [OK].

### 6.2.4 Input of data to the local database

Export the original .ttd file in TinyTag Explorer. Press [View] [Table of readings] and [File] [Export] [All cells] - Use the same filename and save it as a text file (.txt). TinyTag data are saved in the folder (GeoBasis\_YYYY/TinyTag/YYYY/SS\_YYYY) (SS=site YYYY= year).

### 6.2.5 Quick validation of data

- Create the subfolders ‘Original files’, ‘Text files’ and ‘Excel files’ as subfolders to the TinyTag folder. Sort the files so that .ttd files are archived in ‘Original files’ and the exported text files in ‘text files’.
- check the data series in the tinytag explorer software.

### 6.2.6 Validation when connected to the internet

- Open the R-script TinyTagData.R. Make sure that the working directory is correct (first line) and that the name of the correct tinytag text file is specified in all the lines enclosed with the comment ‘### NOTICE ###’.
- Press Ctrl + A and Ctrl + Enter to execute the script. Check that the figures look satisfactory.
- Open the excel file, remove the first column that contains the number of records.
- Control the data quality: Check that the time series are adequate and that the temperature interval looks reasonable.
- Remove defect data and single outliers from the dataset. Interpolate values where single data points are missing.
- Record every manipulation under Status.
- If there are major gaps where date and timestamp is missing, use pivot tables to fill it out, leave the temperature column blank when there is missing data.
- Save the file and move the excel file to the folder ‘Excel files’.
- Add information about each TinyTag logger in the file “TinyTag logbook” (GeoBasis\_YYYY/TinyTags/TinyTag logbook).

### 6.2.7 Troubleshooting

If communication fails:

- Try to change the battery or try to leave the data logger open for drying
- If you bring the logger inside from the cold – do not open until it has reached room temperature in order to prevent condensation.
- Check that you have attached the cable at the right plug on the logger.
- Under “Communications”, the COMport can be specified. Check which COMport the computer uses and make sure the correct one is specified in the Tinytag Explorer Software.



### 6.3 Geo-Precision permafrost temperature

In September 2012 ten Geo-Precision temperature strings were installed in different settings around the Zackenberg valley. Two of these installations are deep boreholes while the remaining are shallow (2m - 5m) satellite boreholes. The installations record ground temperatures in different locations throughout the valley allowing a broader view of the ground thermal regime within the valley. All sites are instrumented with Geo-Precision thermistor strings and data loggers. These systems are quite simple to operate. The whole system is one cylindrical logger (either stainless steel or black plastic) attached by a screw on tri-pin connector to the thermistor chain. Location and coordinates of the logger sites are shown in Fig. 35 and table 2. Below is a short manual on how to offload data. Further information about the sites and maintenance can be found in the manual by Jordan R. Mertes: "Zackenberg Geo-Precision Permafrost Temperature Sensors", which can be found in House 4, in a dedicated cardboard box on top of northern cupboard.

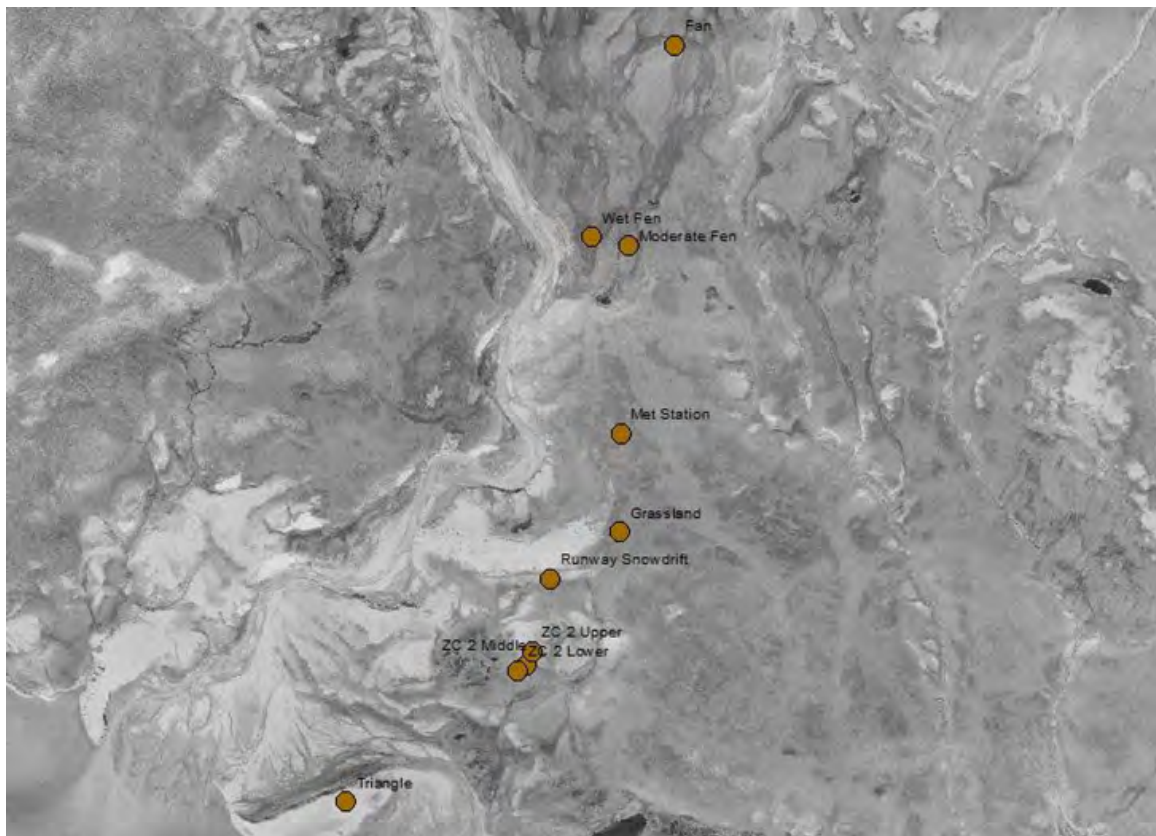

Figure 35: Location of the ten Geo-Precision strings in the Zackenberg valley.

Table 2: UTM coordinates of the ten Geo-Precision strings in the Zackenberg Valley.

Name	Logger ID	Northing	Easting
Grassland	A50454	8264505.00	513383.00
Moderate Fen	Broken	8265608.00	513415.00
Met Station	A50458	8264883.49	513385.22
Runway Snowdrift	A50456 (top) and A50459 (bottom)	8264323.52	513112.34
ZC 2 Middle	Broken	8263992.63	513019.97
ZC 2 Lower	A601C6	8263969.57	512988.11
ZC 2 Upper	Broken	8264043.51	513043.51
Triangle	A5044F	8263464.22	512322.36
Wet Fen	A5044C	8265641.00	513272.00
Fan	A50455	8266383.00	513593.00

### 6.3.1 Offloading data from the Geo-Precision strings

If possible offload the Geo-Precision strings at the site. **Notice:** The data logger doesn't have to be stopped before the readings are retrieved or restarted again.

1. Connect the WIFI dongle to the computer or PDA and start the GP5W Shell software. When it starts, loggers that are within range will appear in the right hand column and you can click one and then press the button on the left that says "identify logger".

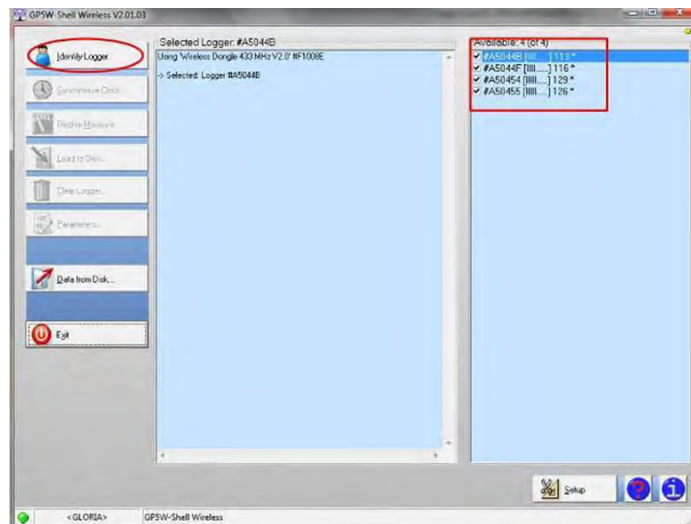

Figure 36: Logger shows itself in the box to the right. Press identify logger to see logger status.

2. Once you have clicked "identify logger" it will attempt to connect, once connected it will give the current logger status such as seen below in Fig. 37.

3. Here you can see the logger's clock, the deviation to the pc's clock, the memory size, percent of memory full, how much data has previously been uploaded, the logging period and the next log time. This should all be set up so the clock is in Zackenber time, and the logging interval should be 1 hr.
4. You can press "synchronize clock" if the deviation is off. Press "display measure" to see a current measurement, "load disk" to download data or "parameters" to adjust the logger parameters.
5. When you press "load disk" it will ask if you want a full download or incremental download (if you've downloaded before). It will then display the data as follows. A new window will open showing a graph and below it the rough data. The GeoPrecision logger SHOULD automatically create a file in its directory named after the logger and the data. However to be safe click FILE-SAVE AS and save a .txt file named LOGGER ID\_SITE NAME\_DATE. If the logger is very full please be sure the .txt file has been created and is up to the date you downloaded (or as close as it could ) and then clear the logger to start fresh.

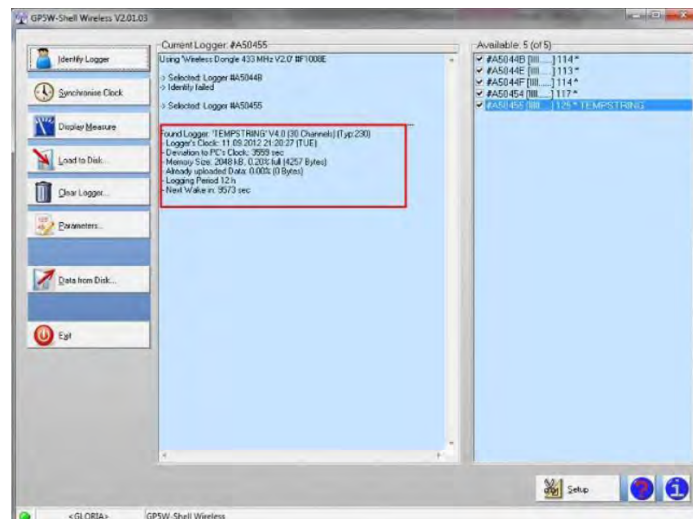

Figure 37: In the red box on the left, battery status, memory status and logger time.

### 6.3.2 Battery change

Batteries must be changed when voltage is below 3.6 v.

### 6.3.3 Contact regarding instrumentation of the temperature strings

Hanne Christiansen (hanne.christiansen@unis.no)

## 7 Support of the ClimateBasis monitoring program

The Climate Station and the Hydrometric station are part of the ClimateBasis program operated by ASIAQ (Greenland Survey). Traditionally, Asiaq staff comes to Zackenberg once a year in order to perform replacements of sensors, reference tests, logger program adjustments, etc. During their visit, GeoBasis staff must be ready to support ClimateBasis staff when necessary. In the field season GeoBasis staff must carry out inspection of the larger ClimateBasis installations and the Hydrometric station if necessary.

### 7.1 The Climate station

All masts are located in the Cassiope heath just north of the eastern end of the landing strip. It is in the central part of the study area on a melt water plain representative of large parts of the landscape and the vegetation in the valley.

#### **East mast (St 640)**

UTM: 8264743 mN, 513382 mE.

Elevation: 45 m a.s.l.

Operation period: 1995-

Instrumentation of the mast: -see ASIAQ

#### **West mast (St 641)**

UTM: 8264738 mN, 513389 mE

Elevation: 45 m a.s.l.

Operation period: 1995-

Instrumentation of the mast: -see ASIAQ

### Radiation mast

Separate radiation mast is placed 10 m south of the main masts.

UTM:XX

Elevation: 45 m a.s.l.

Operation period: 1997-

Instrumentation of the mast: -see ASIAQ

### Precipitation Gauge

The Belfort precipitation gauge is located 5 m north of the masts

UTM: 8264751 mN, 513388 mE

Elevation: 45 m a.s.l.

Operation period: 1995-

Instrumentation of the mast: -see ASIAQ

### Climate Station snow mast (st. 644)

Located 30 m north of the Climate Station in the Cassiope heath right north of the eastern end of the runway. Near grid point (92) in ZC-1.

UTM: 8264774 mN, 513380 mE

Elevation: 45 m a.s.l.

Operation: 1997-

Instrumentation of the mast: -see ASIAQ folders

Data download: Satellite modem on east mast

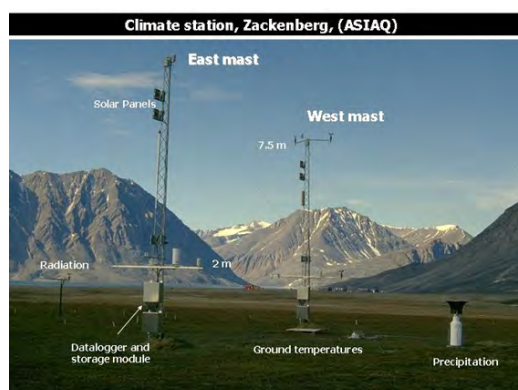

Figure 38: The Climate station includes two almost identical equipped masts. East and West, a separate radiation mast, a separate precipitation gauge and a snow mast (outside the photo). The Zackenberg station is in the background.



Figure 39: Snow depth mast at the Climate Station.

**Notice:** Always enter the climate station from the road/track east of the masts, when visiting. Trampling around the masts must be kept to an absolute minimum to protect the vegetation cover from disturbance. Radiation sensors were moved to a separate mast due to damage of the vegetation below the sensors.

#### 7.1.1 Data storing and power supply

Data are logged by a CR1000 data logger and data is sent directly to Asiaq in Nuuk via satellite communication. The lower enclosure contains batteries which are powered by solar panels located on top of the masts. Data from the radiation mast and the snow mast are saved on the data logger at the east mast.

### **7.1.2 Input of data into the local database**

After every ended season ClimateBasis data will be available from the GEM database (data.g-e-m.dk).

### **7.2 The Hydrometric station**

Details about the hydrometric station is covered in section 8.2.2 Automatic water level monitoring.

### **7.3 Contact:**

Jakob Abermann

ASIAQ

Postbox 1003

3900 Nuuk

E-mail: [jab@asiaq.gl](mailto:jab@asiaq.gl)



## 8 River water monitoring

### 8.1 Introduction

ClimateBasis, managed by Asiaq, Greenland Survey, studies climate parameters and river hydrology in Zackenberg. Traditionally, Asiaq staff comes to the station once a year in order to perform replacements of sensors, reference tests, logger program adjustments, etc. The fact that they are not present permanently throughout the season and the GeoBasis' engagement in other aspects of river hydrology has led to a tight connection between the two sub-programs when it comes to the discharge of Zackenberg river.

The challenge is that discharge in general is not measured continuously. Instead, an ultrasonic sensor measures water level (for instance 15 min intervals in Zackenberg). At several points in time throughout the season, manual measurements are performed (both with an electromagnetic flow meter or a Q-liner) and related to a known water level. The water flow velocity is measured in various profiles (distances from the river bank) and depths (above river bottom). Usually, these profiles follow a logarithmic profile, although turbulences can alter this markedly (Fig. 40). Integration over the entire cross-profile then allows for a calculation of total discharge at one point in time (one dot in Fig. 41). At least 5-10 of such manual measurements ideally spreading over the entire discharge range are necessary to establish a reliable stage-discharge (Q/h) relation (purple line in Fig. 41), with which the discharge time series can be calculated (Fig. 42). A given Q/h relation is valid as long as the river bed does not change and in many locations where solid bedrock exists, it can be used over years. In Zackenberg however, the riverbed is subject to large natural changes mainly associated with the repeatedly occurring glacier lake outburst flood. Therefore, a new Q/h-relation has to be established every season.

GeoBasis is also collecting water samples during the summer season (see chapter 9). These samples are analyzed for different nutrients and dissolved organic matter. These samples in connection with the discharge measurements enable us to estimate the quantity of carbon and nutrients leaving the terrestrial environment, during each field season.

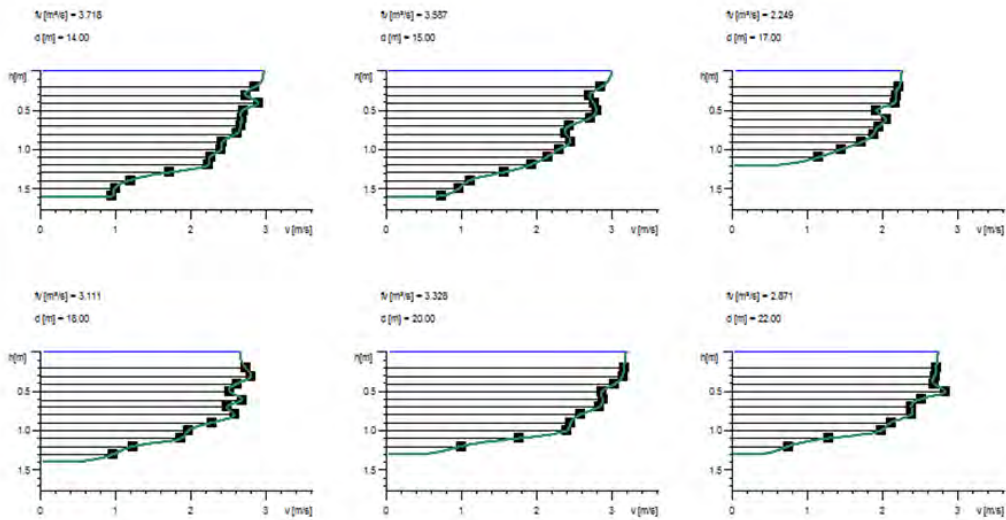

Figure 40: Example of flow velocity profiles at Zackenberg river on 16.08.2014. Note, that not all profiles follow a perfect logarithmic curve.

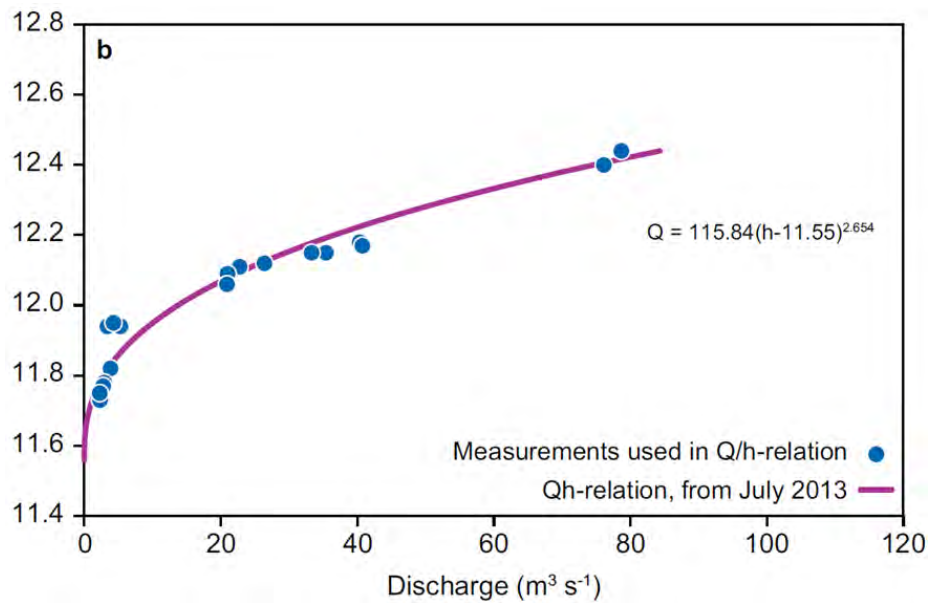

Figure 41: The Q/h relation for Zackenberg river for late 2013 with manual measurements (blue dots) and the derived relation (purple line). A new one had to be established after the GLOF from July 2013.



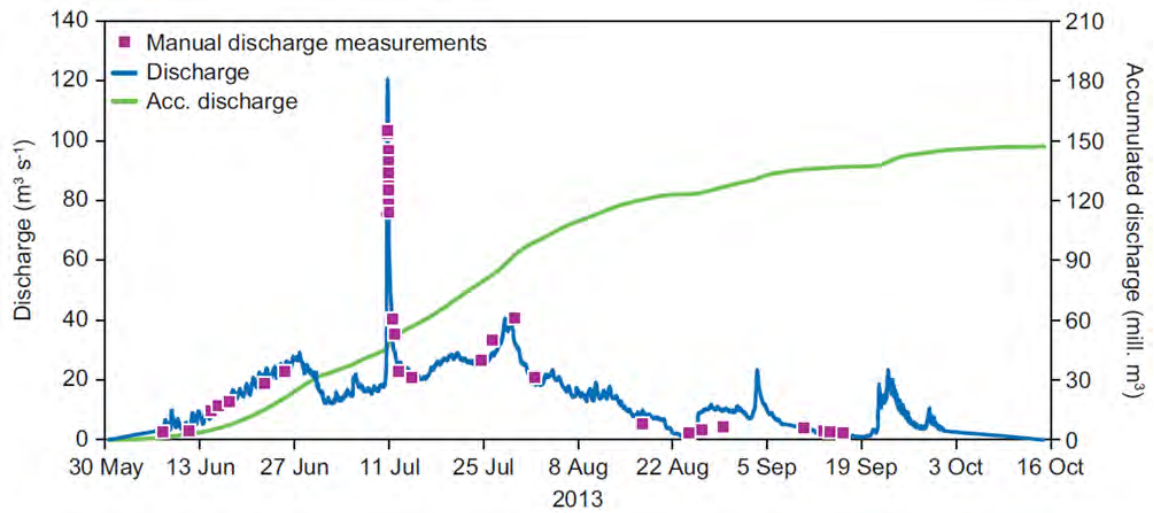

Figure 42: A typical season's discharge of Zackenberg river with manual discharge measurements (purple squares), the derived discharge time series (blue) and the accumulated discharge (green line).

### Parameters to be measured

- Waterlevel
- River discharge ( $Q$ )
- River water chemistry
- Suspended sediment
- Suspended organic matter

## 8.2 Water level monitoring

Continuous recordings of water level in Zackenberg River are used for discharge calculations of the total runoff from the  $512\text{km}^2$  catchment/drainage area outlined in Fig. 43.

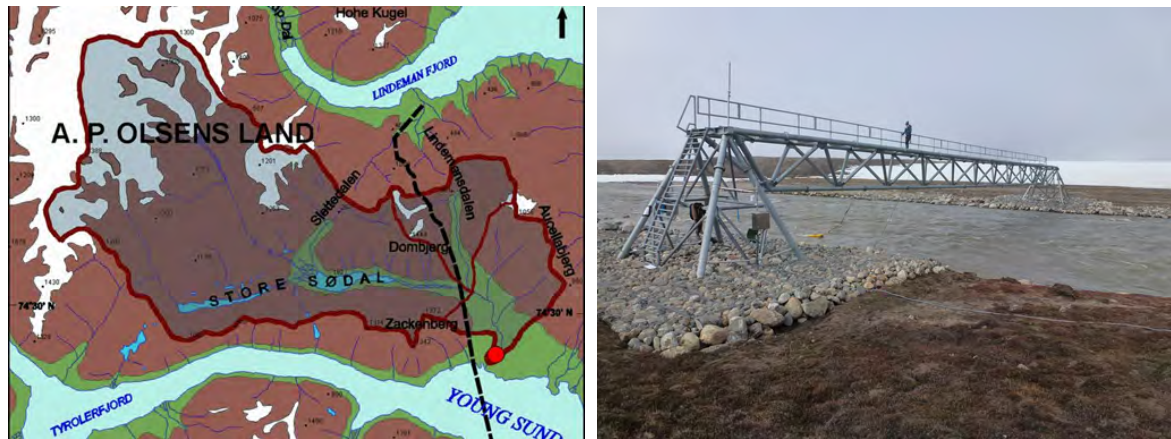

Figure 43: Map showing the Zackenberg drainage basin ( $512\text{km}^2$ ). The hydrometric station (red dot) is located approximately 1-2 km up streams from where the Zackenberg River drains out in Young Sound (left). A photo showing the bridge and surroundings of the hydrometric station.

### 8.2.1 Manual water level monitoring

Manual water level readings are performed using a laser range finder (Fig. 44). The range finder is used to measure the distance from the bottom of range finder to the bottom of the bridge, more specifically to the ‘inner top’ of the hoist trolley. On the pole of the range finder there is a ruler and the water level is read on this rule. Thereby, the distance between the water and the bridge can be determined (by adding the two distances), which allows assistants to measure the water level anywhere in the cross profile, without deploying any permanent installation, that may break during spring break up.



Figure 44: Correct mounting of range finder on pole with ruler (two leftmost photos) and placement of pole foot on a point directly under the hoist trolley (right photo).

- 1) Place the pole with the rangefinder mounted just below the hoist trolley (Fig. 45).
- 2) Turn on the range finder on the red, round button.
- 3) Make sure that the range finder is set to measure the distance from it's own bottom to the object it's pointing towards (there is a small icon in the upper left corner indicating the settings – if wrong; change it by pressing the icon with the arrow, just below 'FUNC').
- 4) Point the laser (small red dot) into the hoist trolley – make sure the range finder is levelled (Fig. 45).
- 5) Press the round button to perform a measurement.
- 6) Repeat the measurement 3-4 times to make sure the reading is consistent (that way you are sure that the laser didn't accidentally point to the outer/lower part of the hoist trolley).



Figure 45: Measuring water table using the range finder and pointing it into the hoist trolley (left). Make sure the rangefinder is levelled using the small bobble level mounted on the pole (right)

## Frequency

Measure the water level manually immediately after river break up.

Until water is running underneath the automatic water level sensor, manual water level measurements should be performed four times a day (in the beginning and end of manual discharge measurements (see section 8.3)).

When the river bank and bed is affected by snow and ice and there is running water under the distance sensor, measure the water level manually four times a day (in the beginning and end of manual discharge measurements), every third day.

When the river bank and bed is free of snow and ice, measure water level manually once a day, every second or third day. Or whenever passing by the bridge.

During extreme events, where the water level is unusually high, like during a glacial lake outburst flood (GLOF) or extreme precipitation events, measure the water level manually as often as possible, while anyway measuring water discharge (see chapter 8.3).

### **8.2.2 Automatic water level monitoring**

The hydrometric station (st. 642) consists of a sonic ranging sensor mounted on the bridge and a OBS sensor, conductivity sensor and divers mounted on a rack and installed on the riverbed. The station is part of the ClimateBasis programme and operated by ASIAQ, data is send via satellite connection to ASIAQ in Nuuk.

#### **History**

The Hydrometric station was first established on the western side of the river but in 1998 the hydrometric station was moved to the eastern bank due to problems with the station being buried in snow early in the season. In 1999, the hydrometric station was flushed away in a spring GLOF and again in 2005, the station was flushed away in a major flood in July. Due to a change in the river cross profile in 2005, the station was rebuilt 30-40 m south of the old location. The power supply and data logger box was also moved at this occasion. In late November 2009 a flood ripped of the sensor and part of the cross arm. In august 2012 a very big surge destroyed the whole hydrometric station, including the setup for QLiner and remodelled the riverbed. After the flood the data logger box was moved approx. 100 meters downstream in August 2012. In the spring of 2014 the hydrometric station was mounted on the new bridge crossing the Zackenberg River. The bridge is located approximately half a kilometer north of the Zackenberg research station.

#### **Data storing and power supply**

Paramters are logged every 15 minutes and data are stored in a data logger (CR1000). A radio link sends data to the eastern climate mast from which data is transferred via Iridium to Nuuk. Batteries are continuously charged by solar panels.

#### **Maintenance**

The sonic ranging sensor has to point directly towards the surface. If it has been bend, please rectify the sensor and write down date and time for this and record how many degrees the sensor was bend. Remember to measure the water level with the range finder when moving the distance sensor.

### **8.2.3 Installation of OBS sensor, conductivity sensor and divers**

Variation in suspended sediment in the river water is measured every 15 minutes by an optical back scatter (OBS-3) sensor. Conductivity and water depth is also recorded every 15 minutes by a conductivity sensor and two divers (pressure transducers). The sensors are mounted on a metal construction (Fig. 46). Sensors are installed as soon as possible after river breakup (when the riverbed is ice and snow free) and removed by the end of the season before they freeze in.

### After river break up

The steel device with sensors is left at the hydrometric station where the cables are coiled (Fig. 47). Sensors are protected in plastic bottles.

1. Make sure that the optical pass of the OBS-sensor is clean and pointing into the river in a direction with no obstacles. At least 20 cm above river bed and with no big boulders to scatter.
2. For the conductivity sensor make sure that water can pass freely through the sensor.
3. Two mini divers (pressure transducer) is mounted on the frame as well. The diver is set to log every 15 minutes. See how to start the diver in the Diver Office\_2009.1 manual. Make sure to test the divers before placing them in the river. Test the divers in a bucket with two different water depths and temperatures. Place the baro diver next to the bucket and check data to see if the diver is working properly. Remember to always start the baro diver before starting the mini divers.
4. When sensors are securely fastened to the frame wade into the river and find an area with relatively smooth surface of the river bed and a place where water level is high enough to cover the sensors also when the water level is low. **Notice:** The frame must be wired to one of the big boulders at the shore.
5. When the frame is placed on the river bed make sure the OBS sensor is still pointing into the river and place a few big boulders on the frame. Record the time and how much water there is above the sensor.
6. Wait for at least 3 hours, then determine the water level using the range finder. Do the same once before they are taken out of the river.



Figure 46: Metal frame for installation of OBS, diver and conductivity sensor



Figure 47: Storage of cable and sensors during winter, by the old hydrometric station

### **During the season**

Check every week that the sensor and the sensor pass is clear. Sometimes debris and vegetation or dead fish will get tangled in the wires and cover the sensor, especially after flood situations. Also make sure that the sensor is always covered by water. If not, move the sensor to a deeper spot but remember to register time and water level above the sensor before and after removal!! Measure the water level in relation to the hoist trolley using the range finder (see section 8.2.1). In practice the pressure transducers + OBS is moved several times during the season, due to fluctuating and falling water table, before and after moving the rack measure the water table using the range finder. Always remember to check the divers when they are anyway moved during the main season! Offload the data and restart the divers (according to separate diver office manual). Sometimes they break during strong currents and should be replaced.

### **Preparation for winter storage**

- Follow the wire and bring the metal frame into land. Note: Make sure the position of the divers have been levelled, before they are moved! See section 8.4.
- Coil the cables and place them on the back of the hydrometric station (Fig. 47).
- Unplug wiper from the datalogger in the logger box.
- Wrap the sensors in plastic or foam and protect them inside plastic bottles – then they can be left mounted on the frame.
- Remove the divers from the river. If the divers have been broken during the season, the diver should be brought back to ASIAQ. All divers must be brought back to IGN for check-up and calibration. Remember to bring the USB reader for the divers.

## **8.3 Water discharge measurements**

Manual measurements of the water discharge ( $Q$ ) in the Zackenberg River are needed to establish a  $Q/h$  relation or to verify the existing  $Q/h$  relation for the river. Depending on the river stream velocity and water level, the discharge measurement is made by Valeport electromagnetic flow meter or by  $Q$ -liner or a mix of both. It might not be possible to use the  $Q$ -liner all the way. Shallow parts (where  $WL$  is less than 35 cm) should always be measured with the Valeport electromagnetic flow meter. Prior to and after a discharge measurement the water level in the river should be measured using the range finder, see section 8.4.

### **Frequency**

Discharge is measured as often as possible as long as the riverbed/bank is covered in snow and the Q/h relation cannot be used. Usually, the very first running water is very slushy and often there will be big pieces of ice and snow in the water, which makes discharge measurements practically impossible. Snow and ice on river bed and banks changes the cross profile and result in an altered water level and therefore manual discharge measurements are the only way to get data from this period. Most years the water will start running in channels through the snow, with ice on the river bed. As soon as the water running in those channels isn't slushy discharge measurements should be started.

When the river bank and bed is affected by snow and ice and there is no running water under the distance sensor, manual discharge measurements should be carried out **twice a day, preferably around 10-12 a clock and at 21-22 a clock**, when the water level in the river can be expected to be lowest and highest, respectively.

When the river bank and bed is affected by snow and ice and there is running water under the distance sensor, the discharge should be measured **twice a day, preferably around 10-12 a clock and 21-22 a clock, every third day**.

When the river bank and bed is free of snow and ice, discharge should be measured 5-10 times over the season. Especially measurements at very high and very low water levels are of interest in order to improve the Q/h relation.

When the river starts to freeze, the water level is again influenced by differences in snow and ice, and discharge should be measured **every 3rd to 5th day** depending on how fast the water level is dropping.

During extreme events, where the water level is unusually high, like during a glacial lake outburst flood (GLOF) or extreme precipitation events, the discharge should be measured as often as possible (or at least every second or fourth hour), as long as the water level is changing rapidly.

### **Location**

Discharge measurements are performed along a hoist trolley by the bridge.

#### **8.3.1 Manual discharge measurement using Q-liner**

The Q-liner gives you detailed information about the river flow and provides a bottom/bed profile. It is ideal for rivers 0.3 - 5 m deep. The Q-liner uses Doppler technology to measure the vertical velocity profile. One of the big advantages is that the Q-liner can be operated from the shore through blue tooth communication. Sometimes, it is not possible to use the Q-liner all the way, since the water level is very low in the western end of the cross section (only relevant late in the season, when the water level has dropped). The shallow part of the river is always measured by Valeport electromagnetic flow meter.



## Equipment to be used

- two persons
- Field chart 15: Q-liner skema\_Zackenbergs\_Fast måleprofil
- Q-liner manual made by Asiaq: Hydrologiske målinger, Zackenbergelven
- Q-liner (located in House 2 in a big box) (Remember to charge batteries!! (AA))
- Qliner PDA (Remember to charge!!)
- drysuit
- life vest
- Digital camera
- Range finder/Distometer (Gandalf stick)



Figure 48: Discharge measurements are performed along the hoist trolley. Q.liner is attached to the steel wire.

1. Take a digital photo from the hill east of the Bridge that covers the hydrometric station and the cross profile (Make sure the camera has the right date and time stamp).
2. Take a close up photo of the water table at the stage level (make sure you can read the stage) and the shoreline at the bridge and a photo of the river crossing and the shore on both sides (these photos can be a great help when evaluating the data). Make sure you can see if the river is bordered by snow or not.
3. Fill out the field chart before you start: (water level, distance from the sonic range sensor (lower point) to the water surface, time, type of current meter, distance from Fix point 3 (red bolt) to 0-mark on the wire, distance from 0-mark on the wire to the shoreline. Record comments about anything that might influence the actual measurement; ice in the water, along the shore or in the river bed, big boulders disturbing the laminar flow, etc.
4. The cross profile follows the blue rope of the hoist trolley. Every 1.1 meter on the rope is marked with some white string.
5. Attach the Qliner via the stones to the hoist trolley, with the shortest sling attached to the hoist trolley.
6. Place the Qliner in the water by raising it off the ground in the red rope attached to the

front of the catamaran. One person gets up of the bridge, holding the red rope hoisting the Qliner 1-2 meters above the ground and one person moves the Qliner in the hoist trolley. The person by the hoist trolley should keep an eye on the 1.1 meter markers on the rope and notice how many meters the Qliner is from the 0-mark (the horizontal distance between the 0-mark (Fix 3) and the start of the hoist trolley is 5 meters). When the Qliner is at the first vertical where there is enough water, the person on the bridge carefully lowers the Qliner, making sure it's lowered straight down, by slowly letting go of the two ends of the rope. When the Qliner is placed in the river, give it a little extra rope (so it isn't tight, but also so it doesn't touch the water).

7. Follow instructions given in the Qliner manual and fill out the field chart.



Figure 49: Q-liner boat in the river (left). PDA connected to computer (mid). Attaching the Qliner to the wire (right).

### **Input of data into the local database**

Export data from the PDA to the computer (follow the instruction in the Q-liner-manual).

### **Quick validation of data**

- Use the program Qreview to process the data. Read the operating instructions for the Qreview software.
- Choose [File] [Open] and then the file you want to work with. Check that the velocity profiles for each vertical looks satisfactory. Suspicious measurements can be excluded: [Edit] -remove the tick mark under “valid” in the actual vertical.
- Press [Edit] – First edge position – correct the depth to the average depth between the last depth measured by propeller and the depth in the vertical first measured by Q-liner.
- When all corrections has been performed, press [Apply] and [Recalculate All].

### **Maintenance**

- After the measurement, switch off the Q-liner.
- Clean/dry the Q-liner catamaran and the current profiler after every measurement and ensure that it is never packed in a wet or damp state.
- Make sure the O-ring in the lid looks nice and smooth, if any sediment/gravel has entered between the lid and the thread remove this and rub the O-ring with silicone (can be found in the drawer in the Geo/BioBasis room in house 2).

### **8.3.2 Manual discharge measurements using the Valeport electromagnetic flow meter**

This is only done in shallow parts close to the river banks, if necessary during the main season, and in the fall when the water level drops and the Qliner can no longer be used. Follow the safety instructions for being in the river. Use life west. Use the Q-liner when the water level is above 35 cm in several verticals.

#### **Equipment to be used**

- Two persons
- Life west
- Dry suit
- Folding rule
- Valeport 801 electromagnetic flow meter
- Probe with cm division and grip wrench
- Valeport display unit
- Field chart
- Digital camera
- Range finder/Distometer (Gandalf stick)

1. Take a digital photo from the hill east of the Bridge that covers the hydrometric station and the cross profile (Make sure the camera has the right date and time stamp).
2. Take a close up photo of the distance sensor where you can see whether there is running water under the sensor and the shoreline at the hydrometric station and a photo of the river

crossing and the shore on both sides (these photos can be a great help when evaluating the data). Make sure you can see whether the river is bordered by snow or not.

3. Measure the distance from the water level to the hoist trolley on the bridge using the range finder. see section 8.4.

4. Fill out the field chart before you start: water level, time and distance from 0-mark/Red bolt/fix 3 on the bridge to the shoreline. Record comments about anything that might influence the actual measurement; ice in the water, along the shore or in the river bed, big boulders disturbing the laminar flow etc.

5. The cross profile follows the blue rope of the hoist trolley. Every 1.1 meter on the rope is marked with some white string.

6. Connect and turn on the Control Display unit. The following screen should appear:

```
801 SINGLE AXIS EM FLOW METER
VALEPORT MODEL 801 VER 2.00
EM Ser No 17668 UNIT Ser No 17115
<<<OPTIONS SETUP                CONTINUE>>>
```

In OPTIONS SETUP you can set the basic settings like logging ON/OFF, Beeper ON/OFF, Back light ON/OFF.

7. Choose CONTINUE to get to

```
FIXED AVERAGE 801  HH:MM:SS
TTT      SSS SECS          STOP>>>
REAL AVERAGE          SETUP>>>
+X.XXX +X.XXX M/SEC  SD=X.XXX  START>>>
LOW BATT
```

8. Place the electromagnetic flow meter on the pole with centimeter divisions. The pole is connected with three parts and these may become loose, check that they are tightly fastened, before starting a measurement.



9. One person stays on the shore to check that the person in the river keeps the measuring probe in a vertical position.

10. The velocity is measured in 15-20 verticals across the river. For every 1.1 meter when the river is bank full and in the period when the river is narrow due to snow or ice or low water level for every 0.55 m.

11. Measure the depth of water in the first vertical (using the pole on which the flow meter is attached. If the depth is  $< 30$  cm the velocity measurement is made in  $0.6 \times$  total depth (measured from the surface and down).

12. If the depth  $> 30$  cm the velocity is measured as a mean between the velocity in  $0.2$  and  $0.8 \times$  total depths (measured from the surface and down).

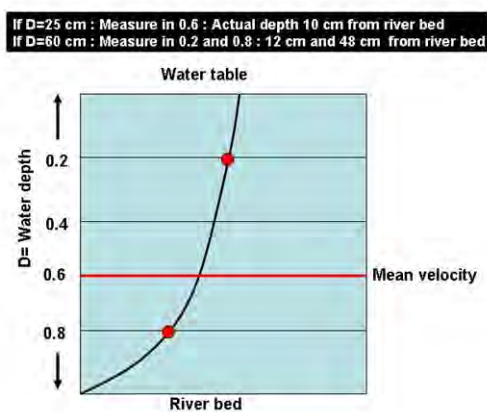

Figure 50: Standard velocity profile in the river and an example of measuring velocity at two different water depths.

13. Place the electromagnetic sensor head in the height you wish to measure and hold it upstream (there is an arrow on the knob on the pole, put the flow meter in the same direction and you can see whether the flow meter is pointing up stream).
14. Press START. The instrument will now have a 10 second initializing period and thereafter start the measurement. Make sure you keep the pole vertical throughout the measurement. During the measurement you can see the real time average in the lower left corner of the display and the number of seconds it's been measuring in the upper left corner.
15. The velocity for each measurement is stored in the memory of the Control Display Unit.
16. For each vertical, record the number of the measurement on the Control Display Unit, the distance to shore and water depth in the field chart. Please note if there is ice or snow on the riverbed.
17. Measure the distance from the last profile to the nearest shore line.
18. Fill out the field chart when you end the measurement (water level, distance from the sonic ranging sensor (lower point) to the water surface, time).

### **Input of data into the local database**

**Note:** If you only made one or a few measurements, it's easier to note down the velocities and standard deviations on the field chart from the display, than to connect to the logger and downloading the data.

1. From the measurement menu (after you pressed CONTINUE), go to SETUP -> OPTIONS -> LOGGING MENU -> EXTRACT DATA.

The following screen will appear:

```

-----
                E X T R A C T   D A T A
                                                U P L O A D > > >

                P L E A S E   C O N N E C T   P C
                                                E X I T > > >

```

2. Connect the Control Display Unit to the PC using the Valeport interface cable.
3. Open Hyperterminal (Y:/Zackenberg/GeoBasis/Software/hyperterminal). Press "Cancel" when it asks for a new connection.

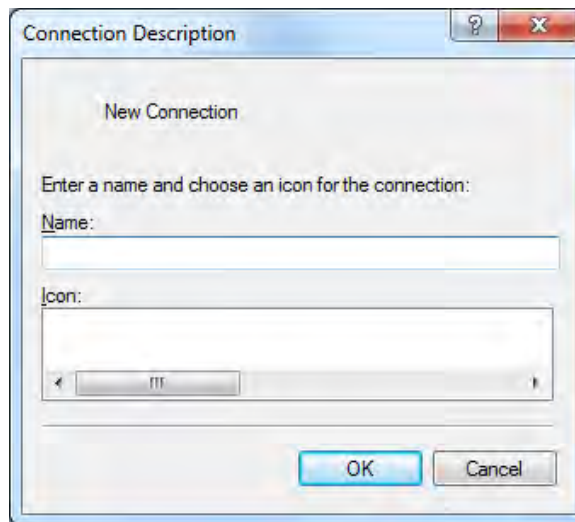

4. Open (File>Open) the file Valeport.ht (Y:/Zackenberg/GeoBasis/Hydrometric Station/Data/2016/Discharge2016/Valeport/Valeport.ht). All the settings that are needed are included in this file (if you have problems connecting, try to change the comport, go to Control Panel/All Control Panel Items/Administrative Tools -> device manager, to see which Com port you are connected to).

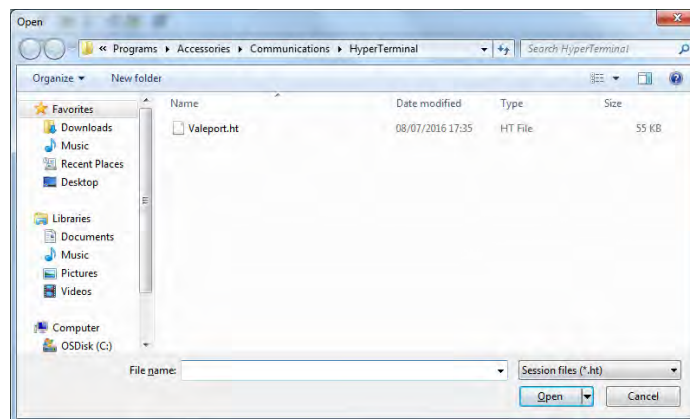

5. Go to Transfer>Capture Text. It will then ask where to save the file and what to name it. You can save it to the desktop and delete it later, as it might not work in other locations (since Hyperterminal is an XP program running in Windows 7). Press “Start”.

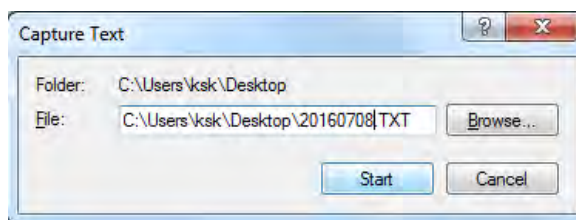
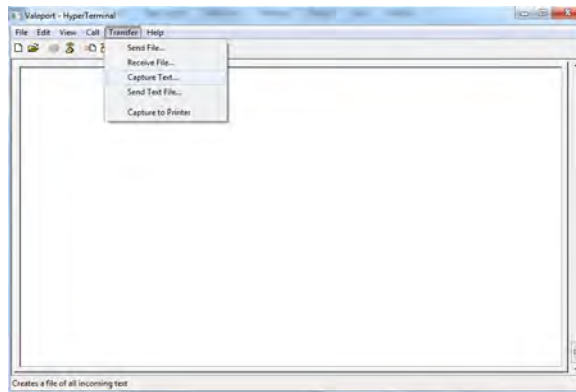

6. Go back to the Valeport display and press “Upload” to start the transmission. The data should appear like this:

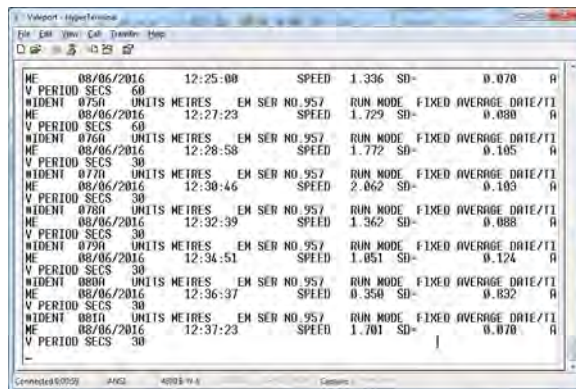

7. When it’s done, close the Hyperterminal. Press “Yes” when it asks whether you want to end the connection. The file will then be closed and can be opened in excel. Depending on how you open the file in excel, you may have to go to Data>Text to columns and choose to delimit by tabs.

8. Input the data, together with the information from the field chart in the template Zackenberg\_Discharge\_YYYY.xlsx in (.../GeoBasis\_YYYY/Hydrometric\_Station/Discharge/Valeport). Make a new sheet for each new measurement.



## 8.4 Level measurements by the bridge

Level measurements are carried out in and around the Zackenberg bridge in order to improve both manual and automatic measurements of the water level and thereby to improve the  $Q/h$  relation and determination of discharge in the Zackenberg River. From 2016 onwards the level measurements before or after the discharge measurements and along with movement of divers are replaced by the range finder. The fix points, the bridge's bottom (where the range finder points to), and the sensor position on the bridge should be levelled 3 times throughout the season in order to ensure fix points in the bridge area are not moving and to determine the exact vertical position of the distance sensor on the bridge.

### Location

The river cross profile under the bridge and the 4 fix points given here:

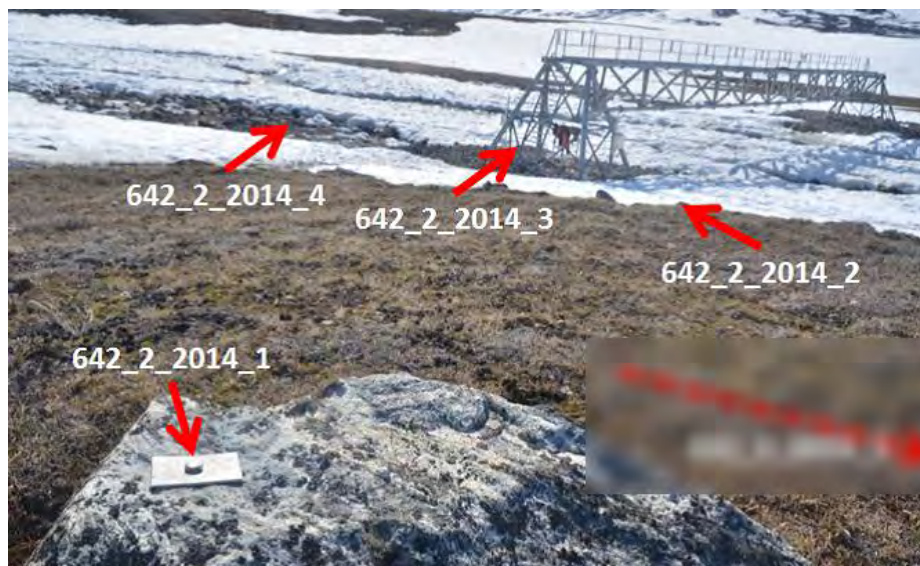

Table 3: Fix points for levelling by the bridge

Point name	Northing	Easting	Height
642 2 2014 1	8265128.226	512980.189	79.405
642 2 2014 2	8265146.124	512958.242	76.111
642 2 2014 3	8265119.925	512952.838	75.130
642 2 2014 4	8265104.565	512942.097	74.207

The individual fix points are marked with a metal plate in which the name of the fix point is written and a bolt (on top of which the ruler should be placed during measurements).

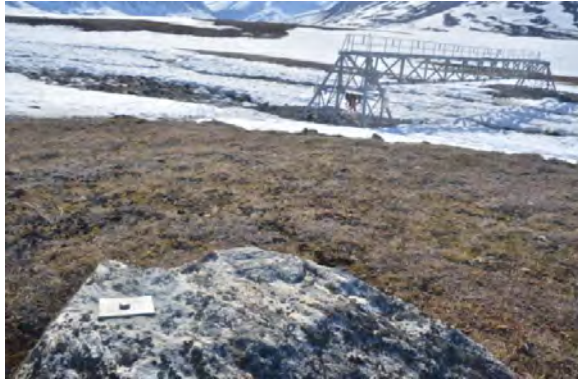

Figure 51: 642\_2\_2014\_1



Figure 52: 642\_2\_2014\_2



Figure 53: 642\_2\_2014\_3



Figure 54: 642\_2\_2014\_4

### Equipment to be used

- Two persons
- Tripod
- Wild NA2 level instrument (can be found in the storage in house2 or 4)
- Ruler for level measurements (wooden 3 meter ruler with mm division)
- 'Libelle'
- Fieldchart 'Nivellement af vandspejl'

### Procedure

1. Place the instrument on the tripod. Make sure the instrument is placed in a higher position than the lowest fix point you are going to measure. If you are uncertain, make a

person stand on the fix point and look through the instrument, the person should now be behind all three horizontal lines in the sight of the instrument.

2. Make sure the instrument is levelled, there is a small 'libelle' on the right side of the instrument, above it is a mirror that enables you to see the 'libelle', even if the instrument is placed high up. Bring the instrument in level, by turning the three nuts under the instrument. Turn the instrument 180 degrees and insure that it is still levelled.



3. Mount the separate 'libelle' on the 3 meter wooden ruler.

4. Note in the field chart which points the measurement is made to (WL, Fix-3, Hoist trolley, etc.), the location, date, time and initials of the field persons. When measuring the water table, it's important to note the precise time (GPS time) of when the ruler is in the water, as these measurements are related to the distance sensor and divers.

5. One person holds the wooden ruler on the fix point (or on a stone in the water, if it's the water table that's being measured). The side with the mm division should be turned towards the instrument. The other person finds the ruler through the sight of the instrument (the instrument can be pushed around and you can 'fine tune' the position by turning the black knob on both sides of the instrument. Make the sight of the ruler sharp by turning the black knob on the right side of the instrument. In the sight you should be able to see a sort of cross (if you can't see the cross, make it sharper by tuning the sight, right where you place your eye). The cross should look like this:

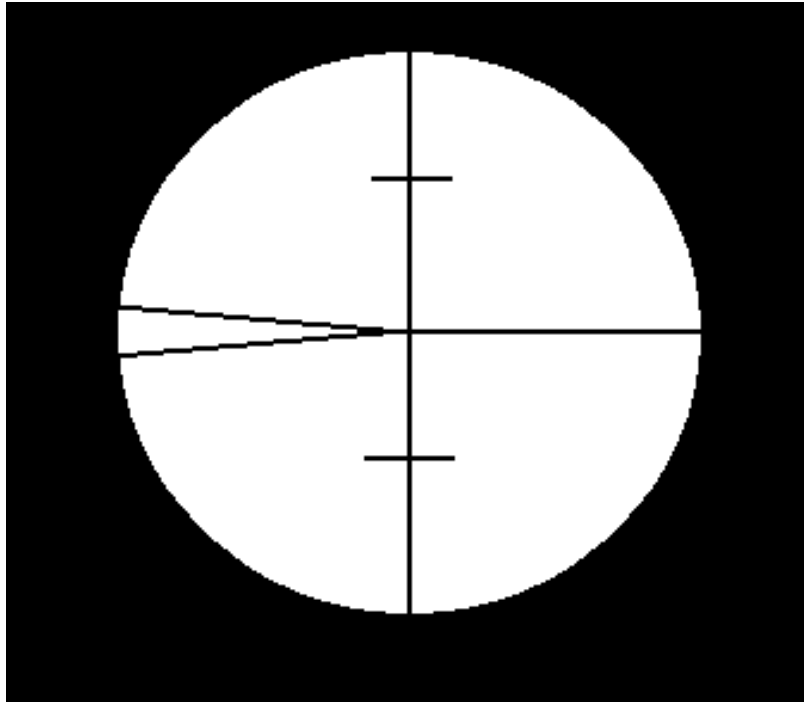

6. On the ruler the person by the instrument should make three readings, one in the middle (called 'Aflæsning [m]' on the field chart), one above (should be noted in 'Over') and one below (noted in 'Under'). The above and below reading should be done to the small crosses in the picture above. In the field chart you can immediately subtract 'over'-'aflæsning' and 'aflæsning'-'under'. The two differences should be the same or not deviate more than 2 mm. 'Over' and 'under' are only used for this 'real time'-validation, to ensure the ruler was levelled throughout the measurement and that the value in 'aflæsning' can be trusted.
7. The person with the ruler moves to the next fix point and the procedure in 6. Is repeated.
8. When all the desired fix points have been measured, move the tripod (doesn't have to be very far, even moving one or two legs is enough), level the instrument and measure all the fix points again. In the end the vertical difference between each fix, w/ or hoist trolley, shouldn't deviate more than 5 mm between the two different setups. If it does, move the tripod again and repeat the whole procedure.
9. When levelling the fix points, also measure the water level under the hoist trolley and the height of the water column above the pressure transducers (using a normal ruler).
10. The advantage of levelling the fix points by the bridge using this method, is that you can validate the measurements instantaneously.

11. Back at the station enter the measurements into the spread sheet ZacElv.xlsx in Y:/Zackenberg/GeoBasis\_2016/Hydrometric\_Station/Nivellering, make a new sheet for each new measurement.

12. Hint: when you measure all the fix points, sensor position, water table and hoist trolley at the bridge you need to place the tripod in different heights in order to be able to read the ruler on all the fixes. Therefore it can be a big help to always include one fix point in all the measurements (e.g. fix 3), as this can then be used to relate the different measurements to each other. However, when measuring Fix 5, which is rather far away from the bridge, fix 3 cannot be reached, instead make several intermediate fixes and measure this fix in relation to fix 1. Fix 1 and Fix 3 can't be measured in one measurement either, since there is more than 4 meters in vertical distance between the two, here you also have to find a steady intermediate fix, preferably a stone.

#### **Proceure for levelling the hoist trolley and distance sensor**

1) When levelling the hoist trolley (to which all manual water level measurements are performed see section 8.2.1), you have to place the ruler up side down, as shown in Fig. 55. Make sure that zero on the ruler is above you. In order to do so, you need to bend the ruler as shown in Fig. 55.

2) The tripod has to be placed relatively low in the landscape (Fig. 55) and you can only relate the hoist trolley to fix point 3 (you cannot use the same tripod lineup for both hoist trolley and distance sensor).

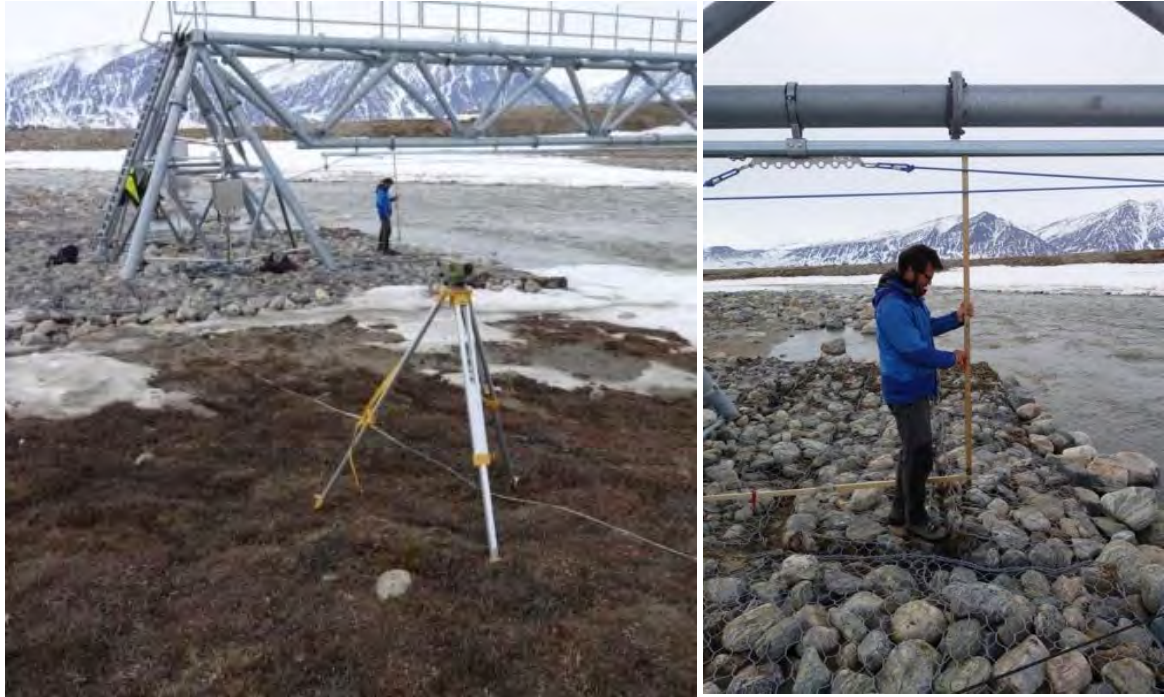

Figure 55: Lineup for levelling of the hoist trolley

3) When levelling the distance sensor position, use the cross-bar above the sensor to place the ruler (see Fig. 56)



Figure 56: Lineup for levelling of the distance sensor

## Frequency

The distance sensor, the bridge's lower part and the five fix points around the bridge should be levelled in relation to each other 3 times per season. Once in the beginning (June), once during the midseason (end July to mid-august) and once in the end of the season (September).

## 8.5 River water sampling

Water samples are collected Monday, Wednesday and Friday in the Zackenberg river. Together with water discharge measurements, total loads of solutes and transport of sediment from the terrestrial to the marine system can be estimated.

### Parameters to be monitored

Z pH

Z Conductivity Specific conductivity

Z Alkalinity

Z Suspended sediment concentration

IGN Organic content of sediment

IGN Chloride (Cl<sup>-</sup>)

IGN Nitrate (NO<sub>3</sub><sup>-</sup>)

IGN Sulfate (SO<sub>4</sub><sup>2-</sup>)

IGN Calcium (Ca<sup>2+</sup>)

IGN Magnesium (Mg<sup>2+</sup>)

IGN Potassium (K<sup>+</sup>)

IGN Sodium (Na<sup>+</sup>)

IGN Iron (Fe<sup>2+</sup>)

IGN Aluminum (Al<sup>3+</sup>)

IGN Manganese (Mn<sup>2+</sup>)

BIO Dissolved organic carbon (DOC)

BIO Ammonia (NH<sub>4</sub><sup>+-N</sup>)

BIO Nitrate (NO<sub>3</sub>-N)

BIO Dissolved total nitrogen (DTN)



Figure 57: US DH-48 depth integrating sampler with 500 ml plastic bottles. To remove or insert the bottle; pull back and turn the handle in the back.

The prefix tells where the analyses are carried out. Z= In Zackenberg, IGN= Department of Geoscience and Natural Resource Management, BIO= Biological Institute.

## Location

Water samples are collected in the Zackenberg river near the scientific station.

## Frequency

Water samples for suspended sediment analysis are collected every Monday, Wednesday and Friday at 8:00 and 20:00. Water samples for chemical analysis are collected every Monday, Wednesday and Friday at 8:00. See field program. During special events like heavy rainfall or sudden increases in sediment concentration due to flood situations or landslides, sampling must be intensified to every second/fourth hour.

## Equipment to be used

- Waders/rubber boots
- 2 x pre rinsed 500 ml sample bottles
- Depth integrating sampler (US DH-48)
- Conductivity meter including temperature sensor (Cond 3310)
- Field chart 7

### 8.5.1 Sampling water for suspended sediment 8:00 and 20:00

1. Place the 500 ml bottle in the US DH-48 depth integrating device. Pull back the rear part of the device and place the bottle as shown in Fig. 58.
2. Wade into the river and collect the sample reaching upstream from the sampling point. Move the bottle/probe slowly at continuously speed up and down through the water profile until the bottle is full (c. 500 ml).



Figure 58: Depth integrating sampler and conductivity meter used during morning and evening sampling ([Update photo of conductivity meter in 2018!]).



## 8.5.2 Sampling of water for chemical analysis at 8:00

1. Rinse the 500 ml sample bottle with river water, by half filling the bottle. Shake vigorously and discard the rinse water before final filling. Fill the bottle, reaching upstream from the sampling point. Leave no airspace in the bottle in order to prevent degassing.

### 8.5.3 Measure conductivity and temperature 8:00 and 20:00

1. Turn on the Cond 3310 and make sure the chi symbol ( $\chi$ ) is shown in the upper left corner.



Figure 59: Display of cond3310 during measurement with nonlinear temperature compensation with a reference temperature of 25 degrees.

2. Under the conductivity and temperature values, information about the type of measurement is given, see Fig. 59. The first  $\square$  determines whether the measurement is temperature compensated or not (TrOff or Tr25, we need both). The second  $\square$  shows what kind of temperature correction is used (linear or nonlinear). For natural waters, like the Zackenberg River, it should be nonlinear (nLF).

3. Measure conductivity and water temperature, by placing the measuring cell directly into the river (the probe must be completely covered), wait until temperature has stabilized and record results. Press 'STO' to save the result.

4. To change the temperature compensation press F1 to open the menu -> push arrow down until 'measurement' is highlighted -> press 'Enter' -> press 'Enter' by the desired method, until a square appears by the selected function -> press arrow down until nLF -> press 'Enter' -> press F1 three times to go back to measuring mode.

5. Repeat number 3. Pay attention to what number the measurements are given when storing them in the cond3310 memory.

6. Note the actual conductivity and temperature, as well as specific conductivity in the water sample field chart in the lab.

### **General observations at the river 8:00 and 20:00**

1. Record general observations as snow and ice drift in the water, snow and ice conditions along the river and in the riverbed and color of the water.
2. Record water level from the stage –and if possible measure distance from SR50a to water surface and distance from river bed to SR50a sensor.

### **8.5.4 In the Lab**

1. The sediment sample (500 ml bottle) is labelled after the following system YYYY-MM-dd HH and stored in the fridge (-or in a Zargesbox) for later filtration (see section 9.5).
2. Measure pH and alkalinity in a sub sample of the water collected for chemical analysis. Follow the procedure provided in section 9.2 and 9.3. Samples should have the same temperature as the pH buffer solutions.
3. Filter 50 ml of the water from the bottle after the prescription in section 9.4 to prepare for later chemical analysis. The 50 ml sample is for chemical analysis at IGN. Label the filtered water sample after the following system: YYYY-MM-dd HH:mm.
4. A subsample of 20 ml water must be filtered after the prescription in section 9.4 to prepare for later chemical analysis. Store this sample in the freezer at -18 °C. Label the filtered water sample after the following system: YYYY-MM-dd HH:mm.
5. At the end of the season (or when possible during the season) bring samples to Department of Geoscience and Natural Resource Management for further analysis. Keep samples cold during transport. The frozen 20 ml sub-samples should be kept frozen during transport and brought to Department of Biology, University of Copenhagen.

### **8.5.5 Maintenance of conductivity meter (Cond 3310)**

The TetraCon 325c measuring cell should be maintained at least once per season before measurements begin in the spring. The measuring cell can experience slight changes due to sediment coatings from the river. Therefore, make sure the measuring cell is clean, wash it in de-ionized water and use a small brush if necessary. Determine the cell constant following the procedure under 4.4.5 in the Cond 3310 operating manual (can be found in the black folder marked 'Analyseskemaer' in house 2).

#### **Contact**

Department of Geoscience and Natural  
Resource Management:  
Vagn Moser  
E-mail: vagnm@ign.ku.dk

Department of Biology  
www.bi.ku.dk  
Anders Michelsen  
E-mail: andersm@bi.ku.dk

### **8.5.6 Input to the local database**

Write results in the spread sheet GeoBasis\_YYYY/river water/River\_water\_YYYY.xlsx. A complete file of all samples must be included when samples are sent to the laboratory. Make sure that the list includes all samples and that the ID in the list corresponds to the ID on the sample-label.

### **8.5.7 Quick validation of data**

Make charts of all parameters and check that the values look reasonable.

## 9 Procedure for Water handling

From the moment water samples are gathered they begin to deteriorate as a result of chemical and microbiological processes. Therefore it is essential to carry out chemical analysis as soon as possible after collection and to store water cold and dark at prescribed temperatures. For longer transportation samples should be stored in a cool/freezer box.



Figure 60: Laboratory in Zackenberg. pH meter next to the magnetic stirrer. The pH electrode is held by the lower clamp and the acid dispenser is held by the upper clamp (left). Analytical balance (middle). Device for filtration of water samples. Filtered water is collected directly into a clean sample bottle. Vacuum is applied by the electrical pump connected to the glass bottle (right).

### 9.1 Conductivity measurement

Conductivity must be measured within 36 hours in an unfiltered subsample. Conductivity is measured in the field or in the station laboratory using a conductivity instrument.

For measuring conductivity see section 8.5.3.

### 9.2 pH measurement

pH must be measured within 36 hours in an unfiltered subsample. pH is measured in the field or in the station laboratory using a pH-meter. The same subsample can be used for both conductivity and pH measurements, but conductivity must be measured first!! The buffer solutions and the water sample must have same temperature when measuring.

1. Notice: If an alkalinity test is made right after the pH measurement, the amount of water used for the pH analysis must be known.
2. Pour 50 ml of unfiltered water into a 100 ml beaker. Use the analytical balance and

record the exact weight of the water in the field chart.

3. Calibrate the pH-meter before making measurements. A two point calibration in buffer solution pH 4 and pH 7 is performed as close as possible to the sample temperature. The following calibration procedure is for a pH 3110 meter.

4. Wash the electrode thoroughly using de-ionized water.

5. Wipe the electrode gently using paper cloth and make sure there are no droplets left.

6. Press 'Cal' -> when the instrument asks for buffer 1, emerge the electrode in 20 ml plastic vial with buffer pH7. Make sure there are no air bubbles around the electrode.

7. Press 'Enter' -> When the instrument asks for buffer 2, take the electrode out of buffer pH7 and repeat 4. and 5.

8. Place the electrode in buffer pH4. Make sure there are no air bubbles around the electrode.

9. Press 'Enter' -> When it asks for buffer 3, press 'M'. Calibration values are shown.

10. Press 'F1' (continue).

11. Repeat 4. and 5. and insert the electrode into buffer pH7 once again.

12. Repeat 4. and 5. and insert the electrode into the unfiltered sample, shake gently to remove any trapped air bubbles and wait for the readings to stabilize (the probe takes time to equilibrate, depending on the ionic strength of the solution it may take several minutes).

13. Record the pH value and temperature of the water sample. If you want to measure alkalinity proceed from here to the next section and start titration on this water sample.

14. Always store the electrode in a storage solution (see operation manual for recommended storage solution) and keep it wet. Never store the electrode in de-ionized water or leave it dry.

15. Change buffers once a week (or more frequently in case of problems with stabilizing measurements), after measurements (to allow the buffer to obtain room temperature before next analysis).

### **9.2.1 Maintenance pH meter**

Prior to using the sentix 81 electrode in the spring (or whenever the electrode hasn't been used for a longer period), leave it in buffer pH4 for half a day. During transport the electrode should be emerged in storage solution. Never leave the electrode to dry.

### 9.3 Alkalinity measurement

Alkalinity must be measured within 36 hours in an unfiltered subsample. Alkalinity is measured in the laboratory by titration of a subsample, using HCl. If alkalinity is not measured the same day as the sample has been taken, then store the sample in the fridge.

1. Pour 50 ml of unfiltered water in a 100 ml beaker. Use the analytical balance for this purpose and record the exact weight of the water in the field chart.
2. Place the beaker on the magnetic stirrer and add a magnet into the sample solution.
3. Insert the thoroughly rinsed and calibrated pH electrode into the sample (make sure that the rotating magnet does not touch the glass electrode. Record pH in field chart when readings stabilize.
4. Fill the 2 ml dispenser with 0.01 M HCl (see Fig. 60). Tap to make sure you have no bubbles and adjust the amount to exact 2 ml (the max amount that this dispenser can hold). **Notice:** To avoid contamination of the HCl never fill the dispenser direct from the bottle. Pour a small sample into a clean beaker/bottle and fill/refill from there.
5. Place the tip of the dispenser in the water and start to add 0.01 M HCl (slowly) into the sample. Give time for the pH-meter to adjust.
6. During the addition of HCl, the water must be gently stirred to mix the solution (magnetic stirrer). Keep adding HCl until pH in the sample solution drops to pH 4.5.
7. In well buffered water samples, a 0.05 or 0.1 M HCl may be used instead of 0.01 M HCl. Notice: If another concentration is used, make sure that the dispenser is rinsed well in between.
8. Record the volume of 0.01 M HCl added in the field chart.
9. Calculation of alkalinity:  $\text{Alkalinity (mmolL)} = ((\text{added HCl (ml)} * \text{concentration of HCl (molL)}) / \text{volume of sample (ml)}) * 1000$ .

### 9.4 Preparation of samples prior to chemical analysis

Samples of river water need to be filtered prior to further analysis. Soil water samples have already been filtered through the ceramic suction probes (pore size: 2 microns). Filtering of samples should take place within 36 hours of collection.

#### Equipment to be used

- Filter funnel assembly (Fig. 60 right).
- Whatman GF/F filters. Glass fibre filters. Retention diameter 0.7 microm. 47 mm in diameter.

- Filtering flask with plastic hose connection and socket (2L).
- Vacuum pump (Millipore).
- Clean sample bottles with cap (50 ml or 20 ml).

1. All parts of the filter assembly must be thoroughly rinsed with de-ionized water. Rinse between samples and use a new filter for every sample.
2. A special string-device (see Fig. 60 right) allows a clean sample/collection bottle to be placed inside the filtering bottle to capture filtered water direct from the funnel. Connect the tube from the filtering flask to the pump.
3. Add some of the sampled water into the funnel on top of the filtering flask. Start the electrical vacuum pump. Fill half the collection bottle, switch off the pump and open for air intake. Move the funnel from the filtering flask and take out the collection bottle. Use these first captured millilitres of filtered water to rinse the collection bottle and cap. After shaking vigorously, discard the water and place the rinsed collection bottle in the filtering flask again.
4. Pour at least 50/20 ml of your sample into the funnel. Start the pump again. When the rinsed collecting bottle is full of filtered water (there should be no air space left in the bottle) switch off the pump. Carefully, move the full bottle from the filtering flask and close the bottle tight. OBS: Since the 20 ml vial are stored in the freezer it should only be 3/4 full
5. Make sure the bottle has the right label including site ID, date, and installation depth before storage in the fridge (50 ml-samples) or the freezer (20 ml samples).
6. Discard the used filter before next sample.

## 9.5 Suspended sediment

Concentration of suspended sediment in the water samples is determined in the laboratory in Zackenberg.

### Equipment to be used

- Milipore filter assembly (millipore 47 mm) (manifold)
- Filters (Whatman GF/F). Glass fiber filters. Retention diameter of particles 0.7  $\mu\text{m}$
- Filter funnel assembly
- Filtering bottle with plastics hose connection and socket (3L)

- Filter cups
- Vacuum pump
- Collected water samples
- Spray bottle
- Filtered water
- Tin foil
- Slidepockets
- Field chart 7



Figure 61: Whatman GF/F filters are used for filtration of suspended sediment samples (left). Milipore filter assembly connected to the vacuum pump. Three samples can be filtered at the same time (Mid). Analytical balance (right).

1. Leave the water samples in the fridge or a dark box/cupboard for at least 1-2 days to allow the very fine sediment to settle.
2. Use the analytical balance to weigh the dry GF/F filters. Record weight of dry filter in the field chart.
3. Place the filter in the manifold funnel assembly and attach the filter cup. A drop of water will help to keep filter in position. Three samples can be run at the same time.
4. Dry/wipe the sample bottle + cap (do not shake) on the outside and record the total weight in the field chart.
5. Pour water into the filter cup. Start the vacuum pump and open the connection to the filter cup (upright position). Keep pouring water until only the sediment rich water is left in the bottle.
6. Shake the bottle and pour the last water in the filter cup. Use filtered water to spray flush the sample bottle and make sure that all sediment grains are flushed out of the bottle.



You can add as much filtered water as you need to clean the bottle – it is only the amount of sediment we measure.

If there is a lot of sediment in the water sample (e.g. because of rain event or GLOF), then split the water sample onto several filters. Do not attempt to work with a filter with < 0.5 cm sediment, as substantial amounts of sediment risk falling off before analysis is carried out at the University of Copenhagen.

7. Weigh the clean empty bottle + cap and record the weight in the field chart.
8. Spray the sides of the filter cup (to move all sediment to the filter) and stop the electrical pump when the sediment on the filter looks dry.
9. Move the sediment filter to a small tray of tin foil. Write a sample label/ID next to the filter. Dry the filter in the oven at 105 °C until the weight is stable.
10. Move the filters into the desiccator and let them cool down to room temperature or leave them in the oven to cool down. Weigh the dry filter with sediment on the analytical balance and record the weight in the field chart.
11. Fold the filter to a half circle and then to a quarter of a circle. Be careful to keep all sediment inside the filter. Wrap the filter in tin foil. Write a label with speed marker on the tin foil. Samples from the river is labelled: yyyyymmdd-HH- DD=day, MM=month, YYYY=year, HH=hour. Place the small package in a slide pocket.
12. Bring samples to Department of Geography and Geology, University of Copenhagen.

### **9.5.1 Input of data to local database**

Write results from the field charts in the template “River water” (GeoBasis/River water and save data in (GeoBasis/River water/Data).

### **9.5.2 Quick validation of data**

Create a chart of sediment concentration versus time and check that values look reasonable. Add any comments that can help in the final evaluation of data in the column “Remarks” (i.e. coarse material, fine material, vegetation parts, colour...).

## **9.6 Bottle and vial washing**

All containers (beakers and bottles) and equipment used in the laboratory must be thoroughly rinsed before use.

Wash in a laboratory cleaning agent. Rinse two times in de-ionized water. Shake to remove drops of water and let it air dry in the rack next to the wash

## 10 Soil moisture and soil water monitoring

### 10.1 Introduction

#### 10.1.1 Soil moisture

Compared to other components of the hydrologic cycle, the volume of soil moisture is small; nonetheless, it is of fundamental importance to many hydrological, biological and biogeochemical processes. Soil moisture information is valuable to a wide range of research studies concerned with weather and climate, runoff potential and flood control, soil erosion and slope failure, reservoir management, geotechnical engineering, and water quality. Soil moisture is a key variable in controlling the exchange of water and heat energy between the land surface and the atmosphere through evaporation and plant transpiration. As a result, soil water plays an important role in the development of weather patterns and the production of precipitation. Simulations with numerical weather prediction models have shown that improved characterization of surface soil moisture, vegetation, and temperature can lead to significant forecast improvements. Soil water also strongly affects the amount of precipitation that runs off into nearby streams and rivers. Available water content (AWC) is the range of available water that can be stored in soil and be available for growing vegetation. Since water/ice have a significantly different thermal conductivity (0.6/2.25 W/m\*K) it is of great importance in active layer modelling to know the amount of soil water that changes phase during the thaw and freezing in the spring and autumn. Soil water content was recognized as an Essential Climate Variable (ECV) in 2010.

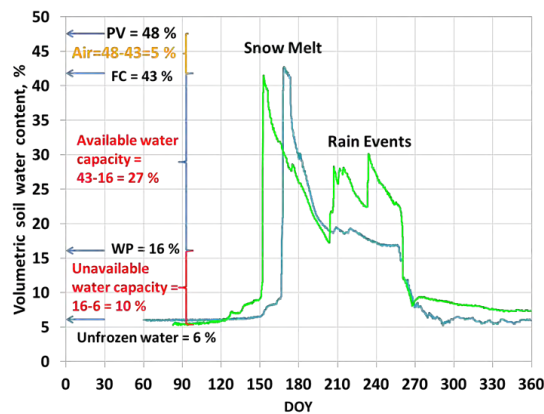

Figure 62: Volumetric soil water content for a sandy soil in a wet summer (light green) and a dry summer (blue). The Pore Volume (PV) is 48 %, the Field Capacity (FC) is 43 % (at the start of the thawing season) and Wilting Point (WP) is approximately 16 %. The Plant Available Water Capacity changes during the summer season with a steady drop in the dry summer and a drop with several rapid increases during rain events in the wet summer. Of the 16 % Unavailable Water Capacity 10 % changes phase between water and ice during thawing in the spring and freezing in the autumn, while 6 % remains unfrozen during the winter season.

### 10.1.2 Soil water chemistry

To address how climate, vegetation, and physical setting control the production of materials such as carbon and nutrients in soil waters, we monitor soil water chemistry and catchment export in areas of different geology and vegetation. To study how hydrology in turn controls the material export from soils to surface waters, we are conducting regular measurements during the growing season. In tundra ecosystems, soil water is an important component of lake and stream water due to the shallow thaw depth and lack of deep groundwater. Therefore soil water is also relatively quickly incorporated into the surface waters, so changes in soil water chemistry can have a quick and large impact on aquatic systems in addition to terrestrial systems. The measurements are also used to determine how these processes are scaled in space and time, and how they influence on the overall Landscape Carbon Balance. Soil water chemistry is governed by soil moisture, landscape age, geological substrate and vegetation. Differences in parent material and soil age result in landscapes with varying soil pH and vegetation composition, which result in the "acidic" and "nonacidic" landscapes common along the Greenlandic coast and throughout the Arctic. In the field pH, alkalinity and conductivity is measured shortly after each soil water sampling. Sub samples are then stored in the refrigerator or freezer, until the samples can be analysed in laboratories in Copenhagen. Here the concentration of anions ( $\text{Cl}^-$ ,  $\text{NO}_3^{2-}$ ,  $\text{SO}_4^{2-}$ ,  $\text{HCO}_3^-$ ), cations ( $\text{Na}^+$ ,  $\text{K}^+$ ,  $\text{Ca}^{2+}$ ,  $\text{Mg}^{2+}$ ,  $\text{Fe}^{2+}$ ,  $\text{Al}^{3+}$ ,  $\text{Mn}^{3+}$ ) and the concentrations of Dissolved Organic Carbon (DOC) and Dissolved Total Nitrogen (DTN) are analysed. Each ecosystem type affects the total amounts of  $\text{NO}_3$ ,  $\text{NH}_4$ , and C:N-ratio in the soil water very differently. This has implications for the input of these nutrients to aquatic systems. Both ammonium ( $\text{NH}_4$ ) and DOC generally shows higher concentrations in surface soils in June than later during summer, most likely due to microbial lysis and release of microbial constituents immediately after snowmelt. Nitrate ( $\text{NO}_3$ ) concentrations are variable but generally higher in the dry Dryas and Cassiope heaths than in the wet Salix snow-beds and grasslands. The deciduous plant communities (fen, grassland and Salix) contain more N relative to C than the wintergreen and evergreen plant communities Dryas and Cassiope heaths, and this plant specific difference is mirrored in the soil C:N-ratios.

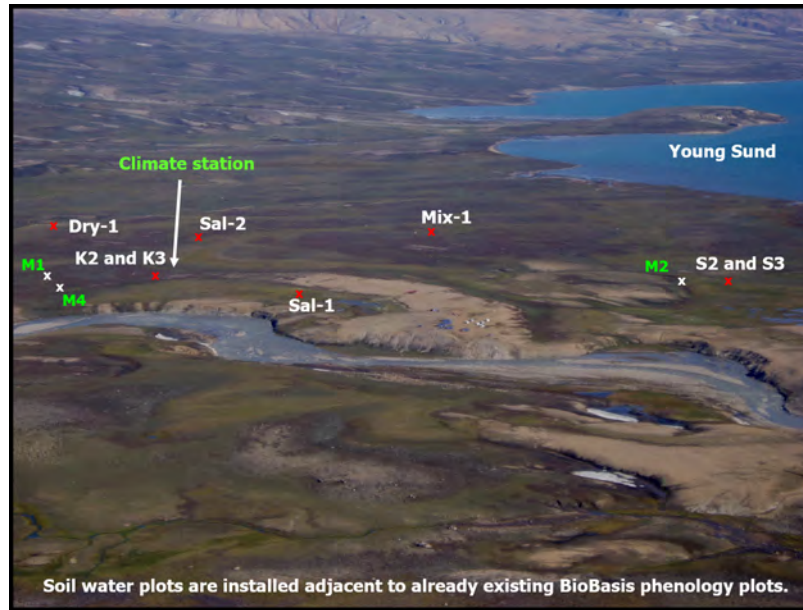

Figure 63: Photo looking Southeast from Nansen blokken. Location of soil water plots are marked by red crosses. Meteorological stations are marked by white crosses. Zackenberg station and the runway are in the center of the photo.

## 10.2 Soil moisture and soil temperature

Changes in soil moisture levels are measured in the active layer beneath dominating vegetation communities in the valley. Measurements of temperature and soil moisture at different levels in the ground give important information on hydrological and thermal properties in the active layer. Soil moisture and temperature strongly affect microbial activity in the soil and thereby control the nutrient release into the soil solution. Soil moisture is measured continuously at four sites (MM2, M2, M3 and M4) and manually at two sites (Sal-2 and Mix-1) and in two transects in ZC-2 (row 1 and row 6).

### 10.2.1 Automatic soil moisture and temperature monitoring

Soil temperature is recorded in several places throughout the valley. Single locations are covered with tinytags (see chapter 6). Soil temperature is also measured at the meteorological stations around the valley (chapter 2). Soil moisture is automatically recorded using soil moisture sensors from Delta T (ThetaProbe ML2x) installed in the active layer. No soil-specific calibration has been performed. Installation depth is given for each station in the section below.

#### Meteorological station (M2)

Located on a south facing slope in the ZEROCALM-2 grid approximately 200 m south of

the runway. The mast is situated on the border between an upper zone of Cassiope and lower zone of Salix vegetation.

UTM: 8264501 mN, 512748 mE.

Elevation: 17 m a.s.l.

Logging time: UTC+0

Installation depth: 10 and 30 cm

Operation period: 2003-

Instrumentation of the station: Table 8, App. A

### **Meteorological station (M3)**

Located on a gently south-west facing slope halfway up Aucella. Approximately 100 m north of this station you find point 100 and 101 on the ZERO-line. The dominating vegetation is Salix.

UTM-coordinates: 8268250 mN, 516126 mE.

Elevation: 410 m a.s.l.

Logging time: UTC+0

Installation depth: 10 and 30 cm

Operation period: 2003

Instrumentation of the station: Table 9, App. A

### **Soil monitoring station heath (M4)**

Located in the almost horizontal Cassiope heath a few hundred meters north of the Climate Station.

UTM-coordinates: 8264868 mN, 513382 mE.

Elevation: 40 m a.s.l.

Logging time: UTC+0

Installation depth: 5, 10, 30 and 50 cm

Operation period: 2005-

Instrumentation of the station: Table 12, App. A

Data storage: CR1000 data logger, CFM100 Compact Flash Memory Module, PakBus address: 94



### **Soil monitoring station fen (MM2SS)**

ICOS soil station south is located 30 m south from the MM2 hut in fen area. Access to the station via boardwalk.

UTM-coordinates: 8265782 mN, 513277 mE.

Elevation: 40 m a.s.l.

Logging time: UTC+0

Installation depth: 2, 5, 10, 20 and 39 cm

Operation period: August 2017-

Instrumentation of the station: Table 18, App. A

Data storage: CR6 data logger, MicroSD, PakBus address: 993

Logging frequency: 1 minute

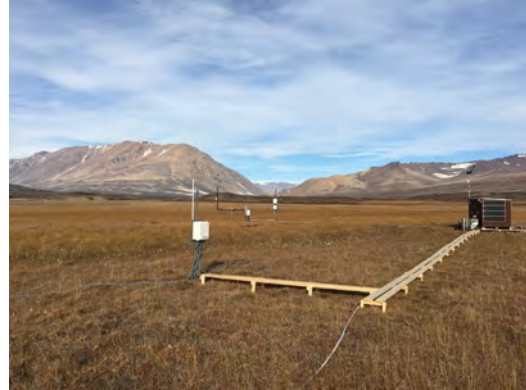

### **Frequency**

Soil parameters: temperature, moisture and soil heat flux is automatically recorded at M2, M3, M4, MM1 and MM2SS. Data is offloaded via wireless communication from the research station.

### **Downloading data**

Follow the procedure given in chapter 2.

### **Input of data to the local database**

Data from M2 and M3 are saved in the directory given in chapter 2. Data from M4 and MM2SS are stored in the GeoBasis directories GeoBasis\_YYYY/M4/Original data and GeoBasis\_YYYY/MM2SS/Original data, respectively.

### **Quick validation of data**

Plot variables in Loggernet RTMC Run-time or copy data to an excel sheet.

Check the time series and make sure that the last logged values corresponds to the date and time for offloading and that there are no major gaps in the loggings.

Make charts for every parameter and examine whether values look reasonable.

Record any remarks that can help in the final evaluation of data in the logbook for the individual stations.

### **Maintenance**

Replace silica gel before leaving the station for the winter.

## **Troubleshooting**

USERS manual from Delta-T Device is located in House 4 together with manuals for most of the sensors, data loggers and power components of the stations.

### **10.2.2 Manual soil moisture monitoring**

Soil moisture is measured manually at two different sites located near BioBasis phenology plots. The sites have almost identical set up. Soil moisture is measured in 5, 10 and 30 cm below the soil surface; same depth as soil water is collected. Soil temperature is measured at the soil surface and at a depth of 10 and 30 cm. Sensor cables and data loggers are stored in a waterproof fiber box mounted on a steel stand/rag. In addition to these in situ readings soil moisture is measured in two transects in the ZEROCALM-2 grid net (chapter 5).

#### **Location**

Soil moisture is measured manually at Sal-2 and Mix-1, see photos in chapter 6.

#### **Frequency**

Soil moisture is manually read as soon as snow melts and the box become visible. During snow melt the sensors are read every second day. When soil moisture has reached a steady level readings are performed 1-2 times a week and right after rain events.

#### **Equipment to be used**

- HH2-meter (Delta-T Device)
  - Notebook
  - Screw driver/leatherman
  - Steel probe with graduation
- 
- Always enter the study plots from the downstream position. Soil sensors are installed upstream from the plot, and the soil above the sensors should not be disturbed by trampling. Site ID is written on the box.
  - When the soil is wet, especially right after snowmelt a wooden boardwalk must be used to protect the vegetation.
  - Open the waterproof box by undoing the string/wire and the four screws.
  - Connect the 25-pin socket from the ThetaProbe to the HH2-meter. The HH2-meter

initially will assume it is an ML2x probe in mineral soil. For other configurations see the User's Guide.

- Press [Esc] to start the HH2-meter.
- Press [Read] and the soil moisture will be displayed in vol %. Press escape twice for a new reading.
- Note the values in a notebook. Installation depths are written at all sensor cables in the box. Record info about the plot (snow, standing water, over land flow, vegetation flowering, etc.).
- Measure depth of active layer just downstream from the site.

### **Input of data to the local database**

Write results from the field charts into the file (GeoBasis/soil moisture/data/soil moisture YYYY). Prepare charts for all sites and depths in order to examine the data.

### **Preparation for winter**

Leave a desiccant bag in the waterproof enclosure/box. Tighten the box to the metal stand using a steel wire. Ordinary ropes are eaten by foxes.

## **10.2.3 Manual soil moisture monitoring in ZEROCALM-2**

In order to record the spatial variation in soil moisture in different vegetation zones, under different snow depth and soil thaw regimes, soil moisture is measured along two rows in the ZEROCALM-2 grid net.

### **location**

Soil moisture is measured in ZEROCALM-2 row 1 (running from the NW-corner to the SW-corner) and row 6 (running N-S passing just west of M2). Altogether, there are 26 grid nodes where measurements are performed.

### **Frequency**

Once a year during high season in late July, start August, preferably at a time where the soil is not affected by major precipitation events.

### **Equipment to be used**

- HH2-meter (Delta-T Device)
- Soil moisture sensor (ThetaProbe ML2x)
- Notebook



- Steel probe with graduation

- 1) Set the HH2-meter to mineral soil type.
- 2) Measure the soil moisture content in three random spots near the grid node stone by inserting the probe vertically from the surface. Read the HH2-meter. Record „water“ if the water table is above the surface which is often the case in the lower part of the grid.

### Input of data into the local database

Write data from the field chart into the Excel template „Soil moisture ZC-2“ (GeoBasis\_YYYY/Soil moisture/ZEROCALM-2) and save the file „Soil moisture ZC-2\_YYYY“ (YYYY= Year) in the GeoBasis directory (GeoBasis\_YYYY/Soil moisture/ZEROCALM-2).

## 10.3 Soil water

Soil water is collected at various depths in soils below characteristic vegetation communities, using soil water samplers (suction cup lysimeters) from Prenart. The suction sampler used in Zackenberg is „Prenart Super Quartz“ made of porous PTFE (teflon) and quartz. In the GeoBasis program both temporal and between sites variations are monitored.

### Parameters to be measured

- Z pH
- Z Conductivity
- Z Alkalinity
- IGG Chloride (Cl<sup>-</sup>)
- IGG Nitrate (NO<sub>3</sub><sup>-</sup>)
- IGG Sulfate (SO<sub>4</sub><sup>2-</sup>)
- IGG Calcium (Ca<sup>2+</sup>)
- IGG Magnesium (Mg<sup>2+</sup>)
- IGG Pottasium (K<sup>+</sup>)
- IGG Sodium (Na<sup>+</sup>)
- IGG Iron (Fe<sup>2+</sup>)
- IGG Alluminium (Al<sup>3+</sup>)
- IGG Manganese (Mn<sup>2+</sup>)
- BIO Dissolved organic carbon (DOC)
- BIO Ammonia (NH<sub>4</sub><sup>+</sup>-N)
- BIO Dissolved total nitrogen (DTN)



Figure 64: Left: Suction probe used in Zackenberg. Pore size: 2 microns. Right: Installed suction probe. A teflon tube connect the probe to the soil surface. Photo not from Zackenberg.

The prefix tell where the analysis are performed: Z= In Zackenberg, IGG= Department of Geography and Geology, BIO= Biological Institut.

## Location

Soil water has been sampled since 1996 at the two main sites in a well-drained *Cassiope tetragona* heath (K1, K2 and K3) and in a wet grassland/fen area (S2 and S3, terminated in 2008). Additional sites in the heath were installed in 2002 and 2003 to obtain information from soils covered by other vegetation communities. Sites were installed in a dry area covered by *Dryas integrifolia* (Dry-1, terminated), in a snow bed area covered mainly by *Salix arctica* (Sal-2) and in a relatively dry area covered by a mix of heath vegetation (Mix-1). From 2012 soil water samples have also been collected from a fen site close to the automatic chamber site. Sal-2 and Mix-1 are described in section 6.2. Today soil water samples are collected from K2, K3, Sal-2 (every second year (odd years)), Mix-1 (every second year (even years)) and in the fen ( 10.3.8).

### K2

The main site K2 is located near the climate station in the well-drained Cassiope heath.

UTM: 8264760 mN, 513365 mE

Elevation: 45 m a.s.l.

Installation depth [cm]: 5, 10, 15 20, 30, 40, 50, 60

Operation: 1996-

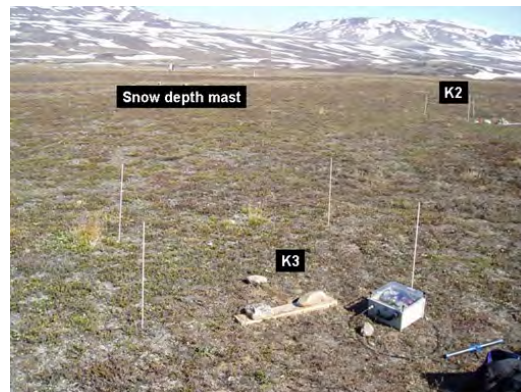

### K3

In 2002 a new installation was made to replace K1.

The new installation (K3) is located adjacent to K2 and has suction probes buried in the same depths.

UTM: 8264753 mN, 513349 mE.

Elevation: 45 m a.s.l.

Installation depth [cm]: 5, 10, 15, 20, 30, 40, 50, 60

Operation: 2002-

### Fen site

North of the automatic chamber site, next to boardwalk.

UTM: 8265562 mN, 513271 mE

Elevation: 35 m a.s.l.

Installation depth [cm]: 5, 10, 30

Operation: 2012 -



## Frequency

Collection of soil water takes place 2 times during the season:

- Immediately after the active layer thaws (end of June).
- During the main growing season (late July/start August).

### 10.3.1 Soil water extraction (heath)

#### Equipment to be used

- Prenart collecting bottles with screw caps (1000 ml)
- (-bottles should be rinsed thoroughly and labelled)
- Handheld vacuum pump or battery vacuum pump
- Field chart 9, App. H
- Pinch clamps
- Silicone rubber tube
- Active layer probe
- Spare-kit (tubes and fittings)

1. At the heath sites, teflon tubes from the buried soil water samplers (lysimeters) are gathered in a box in the soil surface. Each tube carries a label which shows the actual installation depth. **Notice:** Teflon lines must not be exposed on the soil surface as foxes bite them. Hide them in the ground or cover with stones.

2. Use the same bottle for each site and depth throughout the season (make sure there is a label both on the teflon tube and the bottle). Make sure all connections between teflon tube, bottle and bottle cap are tightened, connect the pump to the second outlet on the bottle cap by a small piece of silicone rubber tube.

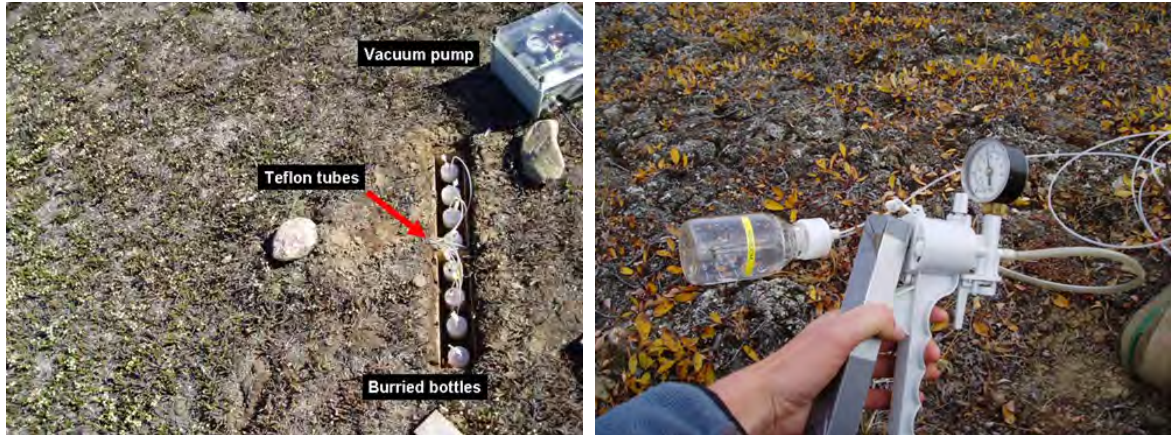

Figure 65: Collecting bottles at the K3 site. Bottles are hidden in the wooden box. To apply vacuum use the automatic pump (mid) or the hand pump (left)

3. Open the pinch clip and ensure that the tubing walls are separate. Apply a vacuum of  $\sim 8$  psi ( $\sim 550$  millibar).
4. Apply vacuum again and leave bottles for another 12-24 hours. Record day and time for application of vacuum in the field chart 9.
5. Depth of the active layer is measured just downstream from the site.
6. Collect water from the site on the next day or at the latest after 5 days.

### 10.3.2 Collection of soil water

#### Equipment to be used

- Plastic bottles. Prerinsed in de-ionized water and premarked with sample ID.

1. Ideally more than 100 ml of soil solution should be collected. Record the volume from the scale at the bottle.
2. Record information about the soil solution (transparency, colour, precipitates etc. . . .).
3. Pour a few ml of soil solution into the plastic bottle. Shake vigorously and discard.

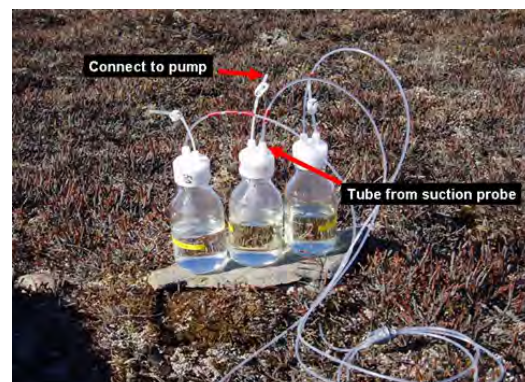

4. Transfer the collected soil solution from the glass bottle to the clean plastic bottle. Make sure that site and depth on the label match the actual site and depth. Bring the water to the station for analysis.

### 10.3.3 Laboratory work

- Conductivity is measured in the unfiltered soil water sample according to the procedure given in section 9.1.
- Fill a pre-rinsed 20 ml vial with a sub sample of soil water for further analysis (leave space for extension due to freezing of this subsample).
- Fill a pre-rinsed 50 ml vial with a sub sample of soil water for further analysis. The vial/plastic bottle should be filled to leave no air space. If there is not enough water for a 50 ml vial, use a 20 ml vial.
- Label the vials after the system: YYYY-MM-DD-XX-ID where, ID=site, XX= installation depth, YYYY=Year, MM=Month and DD=Day.
- Store the 50 ml sample cold  $<5^{\circ}\text{C}$  and dark.
- Store the 20 ml sample in the freezer  $<-18^{\circ}\text{C}$ .
- The rest of the sample is used for pH and alkalinity analysis. Preferably 50 ml are needed but in case of limited amounts, samples down to 15 ml can be used. pH and alkalinity tests are made on the same sample according to the procedures given in section 9.2 and 9.3.
- After the season all soil water samples are brought to Denmark. Keep frozen samples frozen during transport and cold samples cold during transport. All 50 ml subsamples are brought to Department of Geoscience and Natural Resource Management for further analysis and frozen 20 ml subsamples are brought to Biological Institute for further analysis. Keep a list of all stored samples for further analysis and include it when handing over the samples to the laboratories.

**Contact:**

Department of Geoscience and  
Natural Resource Management:  
Vagn Moser  
E-mail: vagnm@ign.ku.dk

**Contact:**

Department of Biology [www.bi.ku.dk](http://www.bi.ku.dk):  
Anders Michelsen  
E-mail: andersm@bi.ku.dk

Analytical methods used to analyse the water samples at Department of Geoscience and Natural Resource Management are described on the homepage [www.ign.ku.dk](http://www.ign.ku.dk) under 'About the Department' - 'Laboratories'.

#### **10.3.4 Input of data to the database**

Write results into the Excel template (Geobasis/soil water/Soil water\_YYYY) and save the file.

#### **10.3.5 Quick validation of data**

Prepare Excel charts of every parameter from every site and depth and check that values look reasonable.

#### **10.3.6 Maintenance**

Prenart super quartz soil water samplers consist of a 95 mm long cylindrical ceramic probe (21 mm in diameter). In one end, a 5 mm teflon tube links the probe to a 500 ml glass collecting bottle.

#### **Replacement of suction probes:**

- Suction probes can work for years without any problems but clogging and bad hydraulic contact may cause a need for replacement.
- Follow the procedure for installation given by Prenart equipment ApS and see the Danish version of the GeoBasis manual from 2002. Time for installation of new soil water samplers should be recorded in the soil water logbook.

#### **Preparation for winter storage:**

- Leave the glass bottles in the field with open tubes. Then at the beginning of a new field season rinse the glass bottles with deionized water and then the first water that is sampled from the soil.

#### **10.3.7 Troubleshooting**

If the collection bottle is losing the applied vacuum:

- Check if teflon tube has damages or chewing marks

- Check that all connections are tightened and fittings are OK. It sometimes helps to change fittings, bottle, or cap for a better fit.

### 10.3.8 Soil water extraction (fen)

#### Equipment to be used

- 3 portable water extraction tubes
- 3 syringes
- 9 250 ml bottles
- Folding rule
- Field chart 9, App. H
- Active layer probe



### 10.3.9 Collection of soil water

There are no permanent suction probes installed, as these very easily clog up in the fen. Therefore portable water probes are used.

1. Open the three way connector on the portable water extraction probe (align the long tabs that are 180 degree apart vertically).
2. Measure the distance of desired sampling depth from the top hole and upwards, make a mark. Insert the probe into the peat with the mark in the level of the soil surface.
3. Insert the syringe into the three way connector.
4. Extract 5-10 ml water into the syringe, close the three way connector: by tilting the connector so the 180 degree long tabs are no longer vertically aligned. Remove the syringe and pull in air until the entire volume is full. Shake the syringe and discard the water.
5. Insert the syringe into the three way connector, open the three way connector and extract 10-15 ml water. Close the connector, remove the syringe and empty the water into a sampling bottle. Close the bottle and shake vigorously, discard the water.
6. Insert the syringe into the three way connector, open the three way connector and extract a full syringe volume. Empty the water into the sample bottle. Repeat until 150 ml are sampled.

7. Take three replicates, with at least 5 cms horizontal distance, from each sampling depth. Bring the water to the station for analysis, see sec. 10.3.3.

#### **10.3.10 Troubleshooting**

The probes sometimes clog, when this happens take out the probe and press air through the probe with the syringe.



## 11 Gas-flux monitoring

### 11.1 Introduction

The land-atmosphere exchange of greenhouse gases and energy in the Arctic is a crucial process in the context of climate change. Arctic ecosystems contain large stocks of soil organic carbon; these stocks are a result of net carbon accumulation during thousands of years due to cold and poorly aerated soil conditions inhibiting decomposition rates. Changes in climate, including increasing temperatures and altered hydrology, will result in significant changes on the CO<sub>2</sub>, CH<sub>4</sub> and energy fluxes, which are likely to pose a strong feedback effect on global warming. Long-term monitoring of greenhouse gas and energy exchange is therefore of uttermost importance.

Across the GeoBasis monitoring sites (Zackenbergl, Nuuk, Disko), two methods for assessing these exchanges are used. Eddy covariance stations measure fluxes on a landscape scale, where fluxes are calculated based on the covariance between vertical wind speed and scalar of interest (i.e. CO<sub>2</sub>, H<sub>2</sub>O and temperature). Automated chamber systems enclose a well-defined area at a plot scale; and fluxes are calculated based on the rate of concentration (CH<sub>4</sub>, CO<sub>2</sub> and H<sub>2</sub>O) change during chamber closure. The acquired data from these stations can thus be used to calculate carbon and energy budgets, as well as to study the variation in fluxes under various meteorological conditions.

In Zackenbergl, eddy covariance measurements are conducted in a heath area (station MM1) and a fen area (station MM2). Both of these stations measure the exchange of CO<sub>2</sub>, H<sub>2</sub>O and energy (latent and sensible heat). Close to the eddy covariance masts, Interact energy balance masts were erected in 2011, measuring standard meteorological variables including net radiation and soil heat flux, allowing for complete assessment of the energy budgets. Furthermore, the exchange of CH<sub>4</sub> and CO<sub>2</sub> is measured in the fen (station AC) using an automated chamber system with ten chambers.

Figures VIII below show examples of CO<sub>2</sub> fluxes (Fig. 66), energy balance components (Fig. 67), and CH<sub>4</sub> fluxes (Fig. 68).

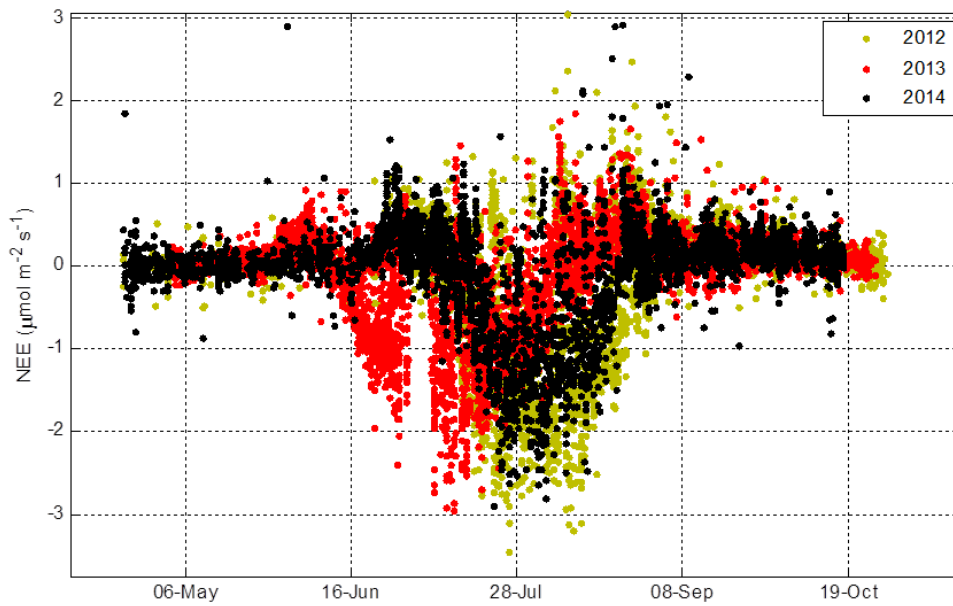

Figure 66: Half-hourly CO<sub>2</sub> fluxes, i.e. net ecosystem exchange (NEE), during 2012-2014 from the eddy covariance station at MM1.

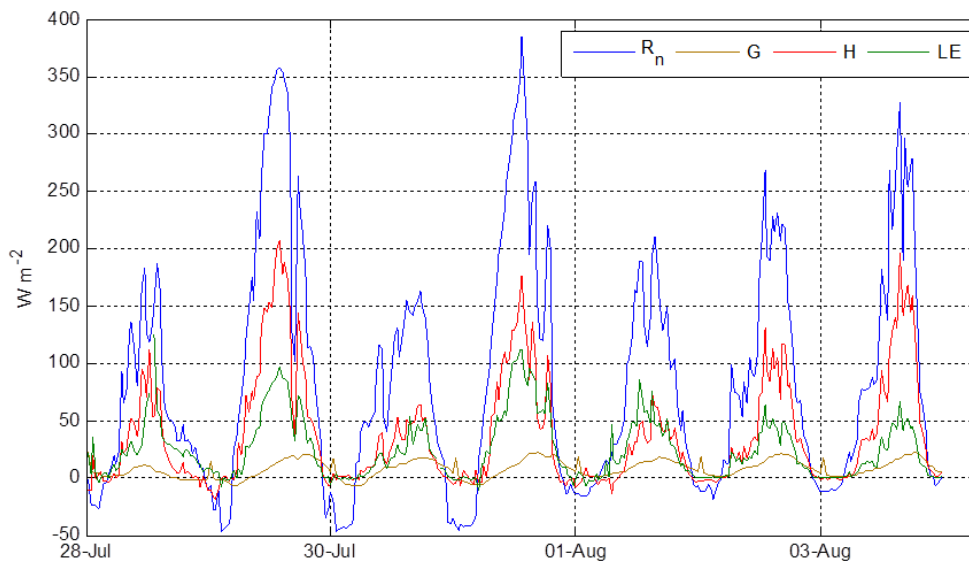

Figure 67: Example of the energy balance components net radiation ( $R_n$ ), soil heat flux ( $G$ ), sensible heat flux ( $H$ ) and latent heat flux ( $LE$ ) from station MM1 in 2014.

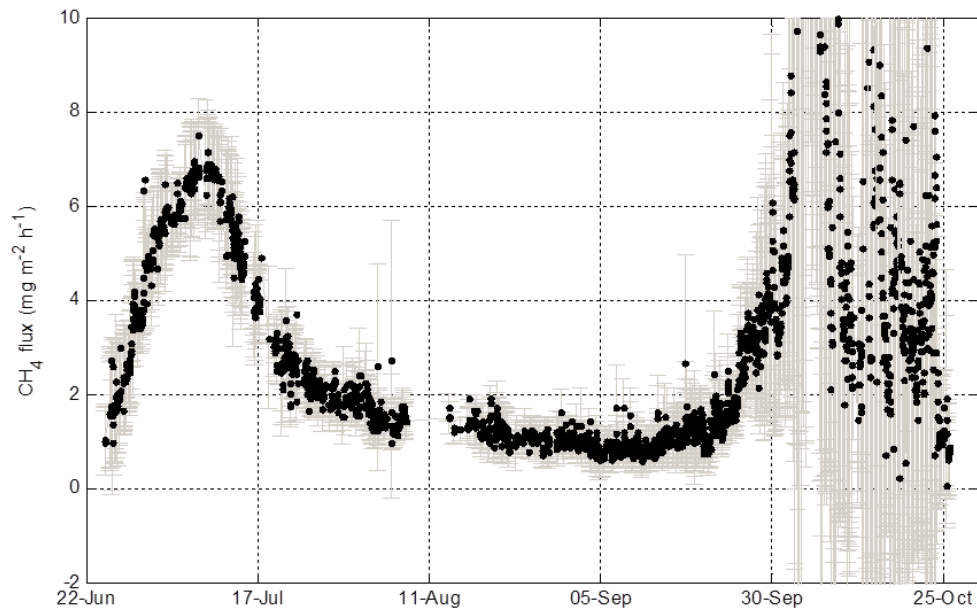

Figure 68: Hourly averages of the CH<sub>4</sub> flux from the AC station in 2007. Grey error bars indicated the spatial variation among individual chambers. Note the high emissions during autumn 2007, referred to as the autumn burst, which has been observed in some but not all years.



Figure 69: View of the Zackenberg valley from Nansenblokken (looking east). To the right the Research station and the runway is seen. The red cross is MM1 and the yellow circle is MM2. Red circle is the Methane station and the white cross mark the position of an abandoned station called M1\_fen (1997-1999 and 2007-2009).

## 11.2 Fluxmonitoring in the heath

The micrometeorological station (MM1) is located in a well-drained Cassiope heath site about 150 m north of the climate station (red cross at Fig. 69).

Eddy mast: UTM: 8264887 mN, 513420mE

Battery box: UTM: 8264888 mN, 513403 mE

Analyzer box: UTM: 8264887 mN, 513403 mE

Elevation: 40 m a.s.l.

Logging time: UTC+0

Operation period: 2000 -

Instrumentation of MM1: see separate manual by Magnus Lund

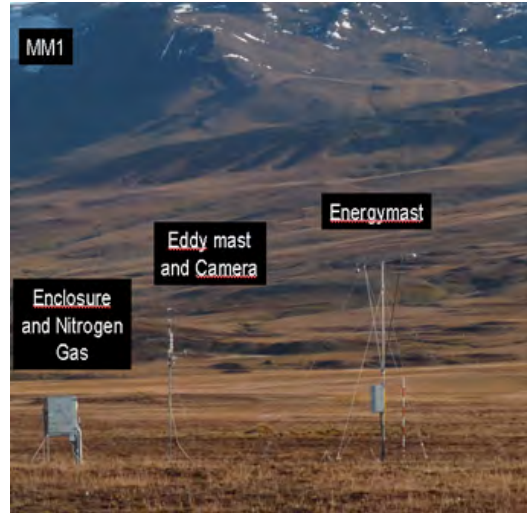

During the winter the station is powered by windmill and solar panels, in the summer the station gets its power supply from the research station itself (see Fig. 71). The enclosure, the eddy mast and the energy mast is permanently situated at the site.

### 11.2.1 Installation of the micrometeorological station MM1

Soon after arrival the CO<sub>2</sub> analyser Licor7000, which is stored at the station, should be connected to the system. 1. First thing to do is to check or change the internal chemicals in the LiCor-7000 (see procedure in Licor manual) and leave the instrument for at least 24 hours before using it. The chemicals should be changed every second year.

2. Download data from the station. See procedure for changing CF cards on the CR1000 in chapter 2.3. Make sure all data has been retrieved, before changing the power supply from the Efoy cells to the main power supply coming from the generator at the station.

3. Transport the following equipment to the site.

- Licor-7000
- Computer (Toughbook) and power cables
- Calibration gas (400 ppm CO<sub>2</sub>)
- Nitrogen gas, 30 liter (can be found in the Geobasis shelter)
- Manual for calibrating Licor7000 (separate manual by Magnus Lund)
- Boardwalks (extra)

- Tools (umbracosæt og topnøgler)
- Strips, Gaffa
- Snow shovel
- Voltage meter
- Flow meter
- Compass
- Bobble level

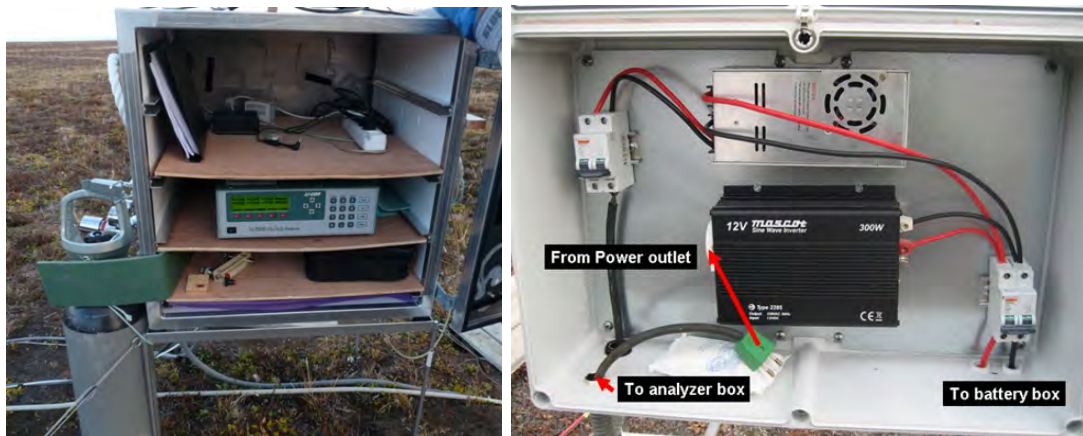

Figure 70: A look inside the enclosure, with the Licor7000, connected the eddy mast and the Nitrogen gas (on the left side of the enclosure) (left). A look inside the transformer box (right).

4. Follow the road/track when you enter the valley. A set of GPS coordinates give you the position of the road and the first part of the road between the runway and the climate station are marked by poles with a green top (placed at the N and W side of the track/road). Always stick to the road!!
5. Check that the masts are fine and completely vertical (use bobble level) and that the sensors are fine. Keep walking around the masts to a minimum, use skies or snowshoes.
6. Remove snow around the enclosure. Make sure there is enough space so that the doors can open.
7. The power cable (220 V) is mounted in a plastic bottle on the steel stand. Insert the power cable through the hole in the bottom of the enclosure. Insert all the cables from the mast through this hole. When all cables are inserted -close the hole by foam material to prevent snow from entering the enclosure.
8. Record the voltage of the batteries before the power cable from the power outlet is connected. Power is supplied from the generator at the Research Station where a power

cable runs all the way to MM1 and further on to the Methane station. There are 4 power outlets along the way. Remember to switch on all power outlets between the site and the Research station. Notice: On is marked by orange and Off is marked by green. On each outlet there are 4 plugs –only plug 1 and 4 are powered (see Fig. 71).

9. From the power outlet 220 V is directed into the transformer/converter box (Fig. 70). Power is converted from 220 V to 12 V which is used to charge the batteries in the battery box. Another set of cables sends 12 V to a transformer that converts 12 V back to 220 V which is the voltage used to run the instruments at this site. Only the external pump use 12 V (a transformer is placed in front of the pump inside the enclosure). If the generator at the station is closed down, the batteries should be able to keep the station running for 2 days.

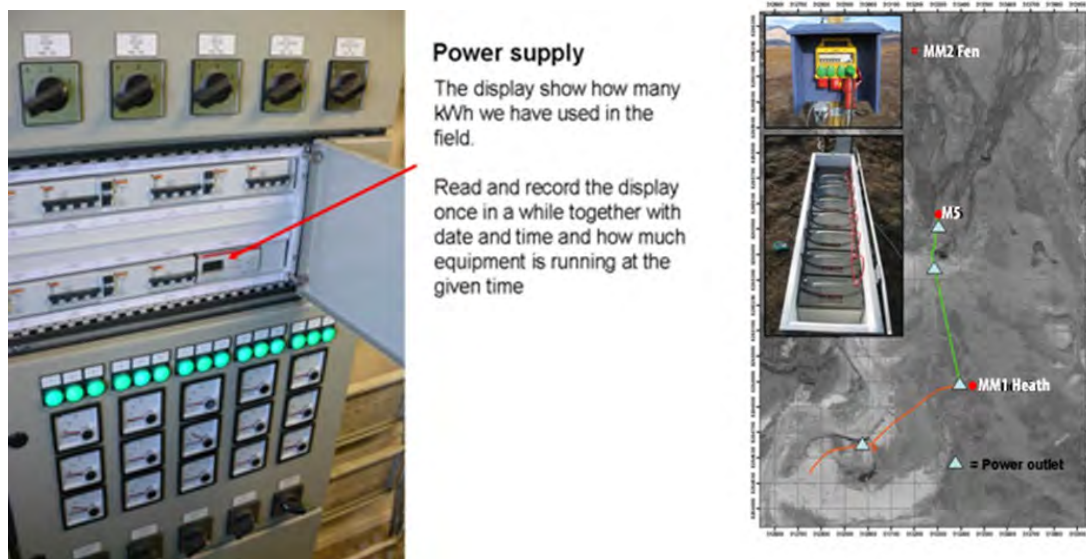

Figure 71: Inside the generator House at the station (left). Map showing the cable that runs from the generator house (left). Inserted photos show one of the power outlets (upper) and the battery box at the Methane site (lower).

### 11.2.2 Licor - start-up

1. Open the flow of N<sub>2</sub> gas.
2. Turn on the Licor 7000.
3. Switch on the external pump on the (On/Off) switch (Fig. 72).

### 11.2.3 Licor - shut-down

1. Switch off the external pump on the (On/Off) switch (Fig. 72).
2. Turn off the Licor 7000.
3. Close the flow of N<sub>2</sub> gas from the bottle.

**Note: The N<sub>2</sub> gas should always be on when the licor is on, make sure the flow of N<sub>2</sub> is open before turning on the licor and do not close the N<sub>2</sub> flow before turning of the licor!**

### 11.2.4 Bi-weekly check of the micrometeorological station MM1

A daily check is carried out in order to prevent data loss in case of break down or failures in the system.

1. Fill out the observation chart for MM1 (Field chart 10).
2. During snow melt; check that the mast is not tilting due to freeze/thaw processes in the soil. Use the bobble level and adjust the mast by tightening the wires.
3. Check the temperature inside the enclosure. The enclosure is insulated in order to prevent freezing during the cold months, but in the summer with direct sun light it can easily get too hot in there. Avoid over heating of instruments by removing the foam that insulates the inlet in the bottom or leave the doors a little open (but still secured). Finally, you may have to remove the insulating material. The operating temperature of Licor7000 is 0-50 °C (that is the Tan, analyser temperature). The instrument will (likely) not be damaged by freezing degrees, but measurements are less reliable. Temperatures above 50 °C should be avoided in all cases.
4. Check the flow rate of the incoming nitrogen gas (see Fig. 72). On the backside of the Licor7000 an outlet tube from cell A leads out to the open air. There should always be a continuous flow from the tube of about 1-2 bobbles per second. Bring a small bottle with water (can be left in the enclosure, as long as the air temperature is above freezing) and insert the outlet tube from cell A into the water. Allow bobbles to escape through the water by orientating the outlet horizontally or slightly upwards inside the bottle. Notice the time on your watch, count 20 bobbles and look at your watch again. If 10-20 seconds have passed the air flow is fine, if not adjust the nubs on the nitrogen gas bottle just next to the enclosure. Allow the flow to stabilize for a couple of seconds, before performing the bobble test again. Repeat this exercise until the gas flow is correct. During the main field season this should be done every third day or whenever great changes in temperature occurs. In the outer seasons it might be necessary to do it every day, because the gas flow is very sensitive to great changes in below 0 degrees Celsius temperatures. Also note the amount of gas content in the gas bottle. If the gas flow is optimal, the consumption of gas should

be around 20 bar/month.

5. Report observations about the weather: wind, wind direction, precipitation, cloud cover, type of clouds, snow cover, snow condition, ground surface and vegetation (Drainage, vegetation condition, flowering. . .).

6. Finally, report any operations or adjustments carried out on the system and check date and time on the computer.

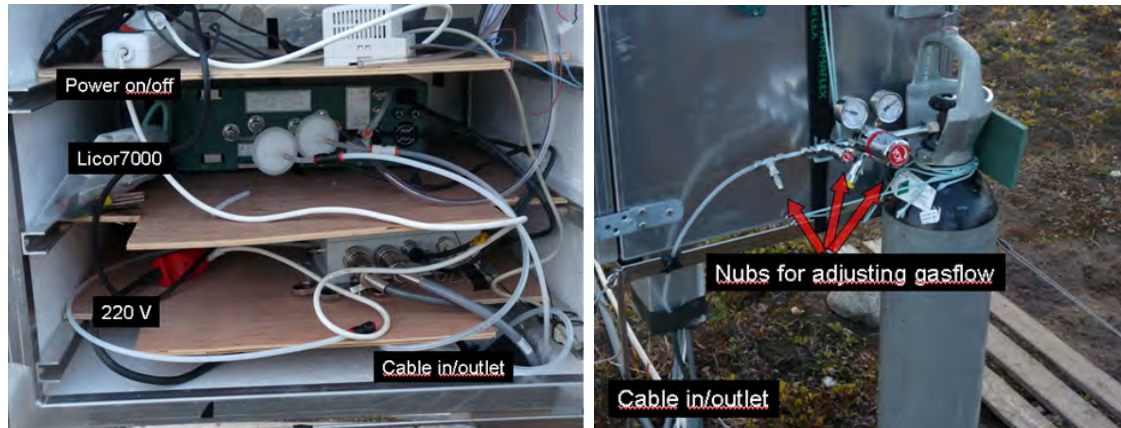

Figure 72: A look into the enclosure from the Back (left) Gas supply for the Licor7000 (right).

### 11.2.5 Troubleshooting

**Notice:** The concentration of CO<sub>2</sub> should range between approximately 370-410 ppm CO<sub>2</sub>, depending on whether there is a net uptake or emission (how photo synthetically active the vegetation is). If the concentration changes within 5 ppm from one day to another, it won't have great impact on the flux, but calibration should be performed if the trend continues. Notice that ambient CO<sub>2</sub> concentration does change during the course of a year; for example, the global mean [CO<sub>2</sub>] was 395 ppm in May 2011 while it was 389 ppm in October 2011 (this seasonal decrease is due to CO<sub>2</sub> uptake by terrestrial ecosystems during the northern hemisphere summer).

### 11.2.6 Changing filters

#### Frequency

The Sample filter (S) in front of the "sample in" cell is changed every month and the Reference filter (R) in front of the "reference" cell is changed yearly. Filters can be changed without calibration, if the CO<sub>2</sub> readings look reasonable. However once in the middle of the season (mid July), a calibration should be performed when the filter is changed anyway. Also, if a significant drop in analyser pressure (Pan) is detected, it may be because



the sample filter is blocked by dirt. Then the filter should be changed. Normal analyser pressure ranges 86 to 92 kPa. (A sudden increase in Pan to ambient levels, i.e. about 101 kPa, indicates a big leak or that the external pump is broken).

#### **Equipment to be used**

- Air filters (Licor art. no. 9967-008)
- Preferably a tube cutter, but a knife/scissor can be used

1. Turn off the external pump.
2. Remove the filter by cutting the tubes near the metal branch on the filter.
3. Connect a new filter to the tubes. Make sure the tube covers the filter branch completely and that the filter is installed so inlet/outlet is in the right direction according to the direction of the air flow (Fig. 72).
4. Start the external pump according to section 11.2.2.

#### **11.2.7 Calibration of the Li-7000 analyser**

Calibration is performed when the system is installed, once in the middle of the season (mid July, in combination with a filter change of the sample cell) and again when closing down the system at the end of the season. Finally calibration is performed if there are any signs of drift in CO<sub>2</sub> concentration that indicate calibration is needed. Follow the procedure given in separate manual by Magnus Lund.

#### **Equipment to be used**

- ECOCYL bottles with span CO<sub>2</sub> gas (of known concentration) and N<sub>2</sub> gas
- Manual in the Black folder: “Li-7000 setup for measurements and calibration” by Magnus Lund

#### **11.2.8 Downloading data**

Offload and backup data at least once a week or whenever you need the data. The meteorological data can be downloaded according to the procedure in chapter 2.3. The licor data should be downloaded according to the procedure given in separate manual by Magnus Lund.

#### **11.2.9 Quick validation of data**

When you’ve copied the MM1/MM2 folder to your computer at the station, there should be two files looking like; I8Zh\_YYYY\_DDMM\_MetData.dat and I8Zh\_YYYY\_DDMM

\_HfData.dat. The HfData file is not in use anymore. The MetData file can be opened in Grapher and new data can be copied into the MM1/MM2\_CR1000\_YYYY.xls file located in the directory: C:/Fluxdata\_YYYY/MM1/MM2. Update the figures and check that data looks alright. If data is from the CF card, open LoggerNet and press "Data". Choose "Card Convert". Locate the file from the CF card and highlight the file. Check the output directory and press "Start conversion". The output file can be opened in Excel and values checked.

#### **11.2.10 Automatic camera at MM1**

On the eddy mast at MM1 a digital camera is mounted. This camera is mainly installed to get visual images from the winter season, when there is no GeoBasis staff present in Zackenberg. The camera is powered through the CR1000 every time it takes a photo, which it does every third hour (at 12, 3, 6 and 9 AM and 12, 3, 6 and 9 PM). The photos can be downloaded from the SD card, by carefully removing the plastic casing in front of the camera, gently flip the camera a bit to the side and push the SD card to eject. Empty the camera soon after arrival to Zackenberg, and then every third week during the rest of the season (e.g. when downloading data). Make sure the camera is running and in a good position before leaving the station in the fall. Remember to empty the camera just before leaving the station in the fall.

#### **11.2.11 Preparation for winter storage**

At the end of the season, the Licor7000 at MM1 is taken down. The energy mast, the eddy correlation mast and the enclosure are left at the site. A senior VIP will help doing this!

1. Span test the Licor-7000 to check that no drift has taken place, see section 11.2.7.
2. Download data from the system, see section 11.2.8.
3. Shut down the system, see section 11.2.3.
4. Make sure that all tubes are closed or connected on the back of the Licor to prevent any open passage into the analyser.
5. Change the power supply from the generator power to solar panels or windmill. This will keep the Interact mast running during winter time.
6. Leave the main switch of the power outlet at the OFF-position.
7. Read the power consumption on the display in the Generator house at the Research station (Fig. 71).

### 11.3 Fluxmonitoring in the fen

The MM2 station consists of an eddy covariance system where CO<sub>2</sub> and wind speed are measured. An energy balance mast and rain gauge have been installed at the site in August 2011.

The micrometeorological station MM2 is located in a wet fen area “Rylekæret” (yellow circle at Fig. 69), c. 300 m north of the Methane station.

Eddy mast: UTM: 8265810 mN, 513267 mE  
Hut/Instruments: UTM: 8265817 mN, 513283 mE  
Elevation: 40 m a.s.l.

Operation period: 2009-

Instrumentation of MM2: see separate manual

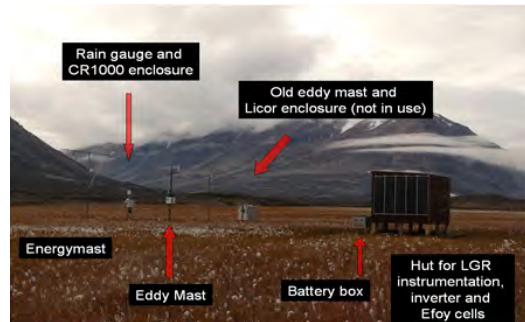

#### 11.3.1 Installation of the micrometeorological station MM2

Soon after arrival winter data from the station should be downloaded from the Licor, see section 11.3.6, and from the CR1000 by changing CF card, see 2.3.2.

#### 11.3.2 Licor7200 - start-up

After data has been downloaded the Licor7200 should be span and zero tested and the housing temperature changed to summer mode. After changing the housing temperature it is necessary to perform a full calibration.

##### Equipment to be used

- Computer (e.g. PDA)
- Snow shovel
- Voltage meter, compass
- Manual for Licor7200
- Bobble level
- Tape and strips
- Ethernet cable or serial RS232 cable

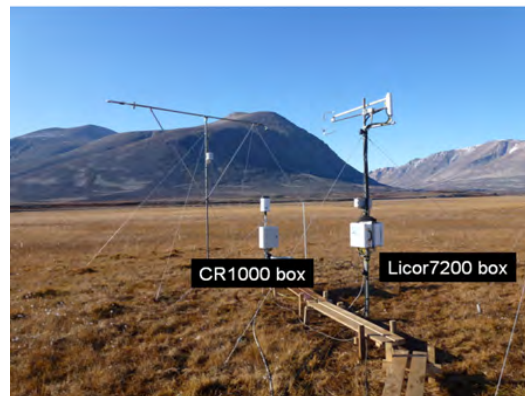

1. Locate the anemometer and make sure this and the energy mast are in level (use bobble

level).

2. If needed further secure the cables and wires around the masts.
3. Connect the computer to the Licor7200 using either an Ethernet cable or RS232 serial cable inside the hut.
4. Perform a span and zero test of the Licor7200 (see section 11.3.4).
5. Change the housing temperature to the summertime temperature (30 degrees Celsius). Follow the instructions given in 'Li-7200, CO<sub>2</sub>O analyser, Instruction manual', section 4 (4-53).
6. Calibrate the Licor7200 following the instructions in the 'Li-7200, CO<sub>2</sub>O analyser, Instruction manual', section 5. The calibration should be performed using one zero gas (nitrogen) and two span gasses (e.g. 400 ppm and 900 ppm CO<sub>2</sub>).
7. The power supply should be changed from windmill and solar panels to power from the generator at the research station.

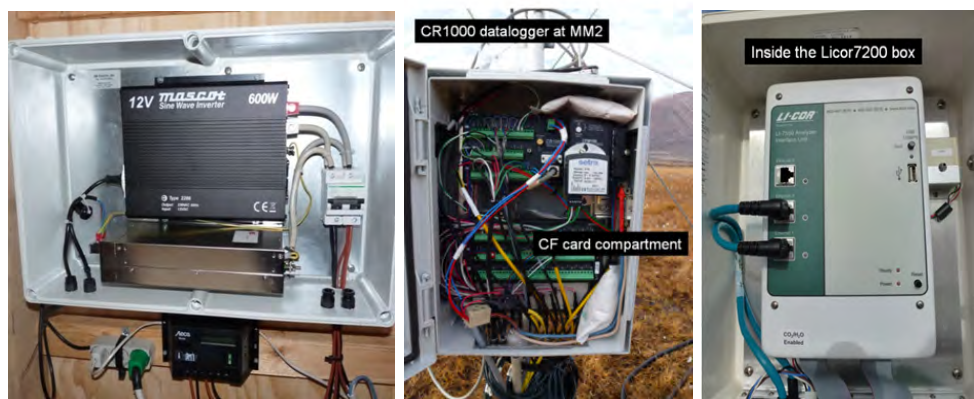

Figure 73: Left: Inverter inside the hut at MM2. Middle: look inside the CR1000 data logger box. Right: look into the Licor7200 box.

### 11.3.3 Bi-weekly check of the micrometeorological station MM2

A daily check is carried out in order to prevent data loss in case of failures in the system.

1. Fill out the observation chart for MM2 (Field chart 11).

2. Report observations about the weather: wind, wind direction, precipitation, cloud cover, type of clouds, snow cover, snow condition, ground surface and vegetation, flowering etc.
3. Report any operations carried out on the system and the exact date and time for all operations.
4. Read water table at the water table site and record it together with date and time (take photos).
5. Note the values from the Licor7200. Follow the instructions from section+ 11.3.4, bullet 1-2 and note the values in field chart 11.
6. Measure the distance from the permafrost to the top of the fix poles (1-5 in Fig. 74).
7. Take photos of the area below the radiation sensors in order to follow changes in vegetation throughout the season.



Figure 74: Active layer sites (numbers) and water level site.

#### 11.3.4 Span and zero test of Licor7200

Span and zero tests should be performed during start up, end of season and approx. once a month or less, to make sure that that the Licor7200 is measuring correct values. Results from the test should be noted in the field chart “LI7200 calibration sheet, ver.2012-03-20”.

#### Equipment to be used

- ECOCYL bottles with span CO<sub>2</sub> gas (400 ppm and 900 ppm) and N<sub>2</sub> gas
- Separate LI7200 manual for span calibration
- Thick bev-a-line tube with back and front ferrule (located in the MM2 hut)
- Computer (e.g. PDA)
- Serial RS232 cable or Ethernet cable for connecting to Licor7200
- Ladder
- Wrench

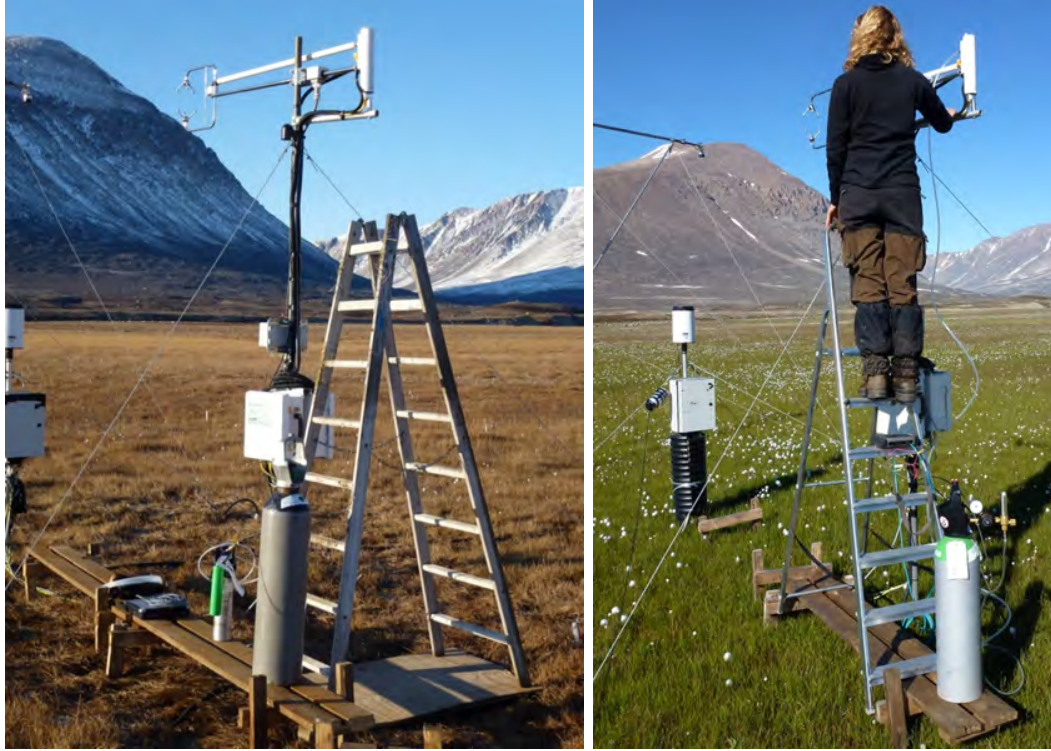

Figure 75: Setup for span testing or calibrating Licor7200. Left; the ladder is used for connecting or disconnecting the Bev-a-line tube for the air intake on the mast (where the white tube is connected to the licor house), Nitrogen and span gas, the computer is connected to the Licor7200 underneath the white enclosure using a RS232 cable. Right; calibration ‘in action’ the reference gas is connected to the licor7200 through the bev-a-line tube and in situ measurements are read from the PDA and noted in the calibration sheet.

1. Connect the computer with LI7200 PC software to LI7200 using the Ethernet cable inside the hut.
2. Start the licor program on the computer. The following screen will appear:



Wait until the programme recognizes the LiCor and suggests the instrument serial number in the field 'Connect to'. For the LiCor 7200 at MM2 I Zackenberg the serial number is 'AIU-0514'. Press 'Connect'

3. The following screen will appear:

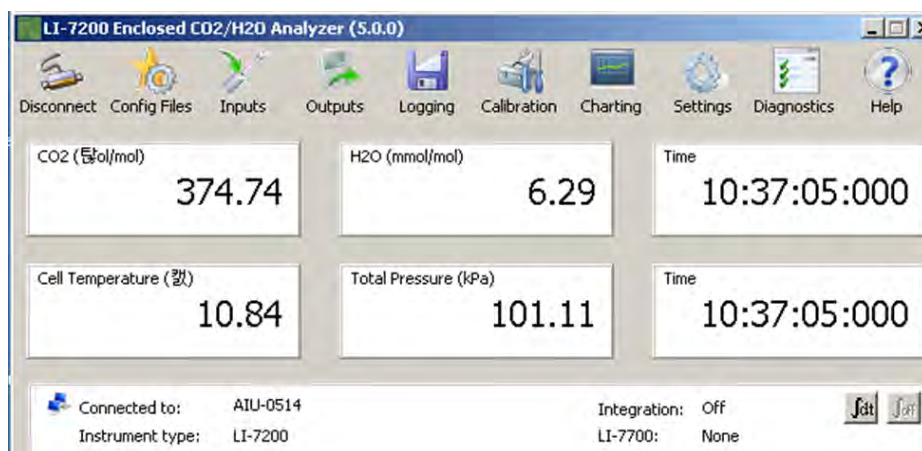

Instead of 'Cell temperature' and 'total pressure' the programme will usually per default show CO<sub>2</sub> and H<sub>2</sub>O in mmol/m<sup>3</sup>. To change this; right click (or hold the pen of the PDA for some time) on the numbers. The window 'Data items' will appear; here you can chose between all the parameters logged and display which ever you wish.

4. Write down the values of CO<sub>2</sub>, H<sub>2</sub>O, temperature and pressure.

5. The Automatic Gain Control (AGC) can be read in "Diagnostics" or put in one of the small windows by holding the pen on the PDA for some time as described above. Typical values for clear windows are near 31 %. The window should be cleaned before the AGC

reaches 52 %. Note the AGC in the daily field chart.

6. Under 'Li-7200' and the tab 'Flow Module' you can read the flow in litre per minute, check that this value is around 15 LPM and note the exact value in the daily field chart.

7. In the tab 'Flow module' you can turn off the flow, by choosing 'Off' in the dropdown menu next to 'Flow'; choose 'Off', press 'Apply' and 'OK'. You should be able to hear, very clearly, that the flow module stops.

8. Place the ladder on top of the board walk, one person should hold it, while the other climbs. Use the wrench to loosen the nut between the LiCor house and the 1 m long horizontal white air intake tube. Be aware of the two small ferrules ('Back ferrule' and 'Front ferrule' on the figure below). **BE CAREFUL NOT TO DROP THEM, AS THEY ARE NEEDED TO KEEP THE SYSTEM TIGHT.**

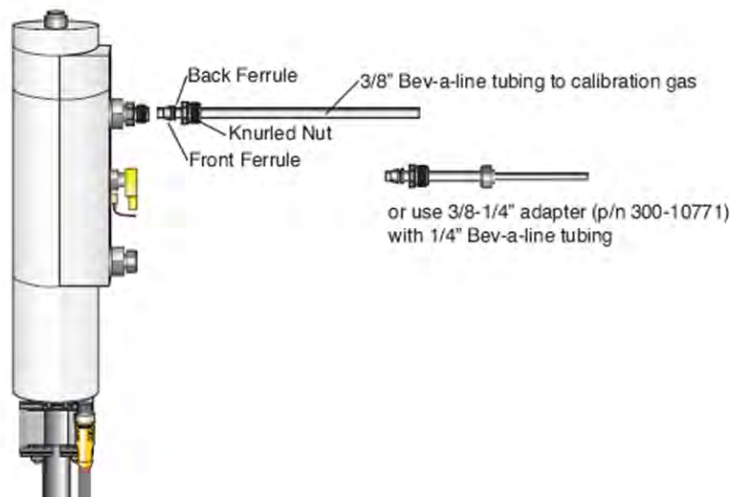

9. Take the knurled nut from the 1 meter long air intake and put it on the thick bev-a-line tube that has a back and front ferrule permanently attached. Use the nut to fasten the thick Bev-a-line tube with ferrules at the end.

10. Note the analytical values of the calibration gasses used in the calibration sheet. These values can be found on the slip of paper attached to the gas bottle itself.

11. Open the N2 to 1 litre per second (always do zero calibration/test before span!) and then connect it to the other end of the Bev-a-line tube. Note: do not connect the gas before turning it on.

12. Flush the Licor with 8 litres per second for 10 seconds, and then turn it down to 1 litre per second again.

13. Wait for the values of CO2 and H2O to stabilize and note the values in the calibration sheet. It might take some time for the H2O to stabilize, make sure that the value is not changing anymore before noting it in the calibration sheet. Also note the temperature and



pressure.

14. If you decide to calibrate, please consult the original li-7200 manual chapter 5. Please note that the system should only be calibrated if CO<sub>2</sub> zero offset > 20 ppm, CO<sub>2</sub> span offset > 20 ppm, H<sub>2</sub>O concentration is < 0.1 ppt or > 15 ppt.
15. Disconnect the gas from the Bev-a-line tube and then turn off the airflow from the gas bottle. NOTE: Always disconnect the zero or span gas from the tube, before turning it off, in order to avoid under pressure in the LiCor house.
16. Open the 400 ppm CO<sub>2</sub> gas to 1 litre per minute, connect to the Bev-a-line tube and flush the system with 8 litre per second for 10 seconds.
17. Turn the flow of the gas down to 1 litre per second, wait for the value of CO<sub>2</sub> to stabilize and note this, the temperature and the pressure in the calibration sheet.
18. Disconnect the 400 ppm CO<sub>2</sub> gas and then close the gas bottle.
19. Open the 900 ppm gas to 1 litre per second, connect to the thick Bev-a-line tube and flush with 8 litre per second for 10 seconds.
20. Turn the flow of gas down to 1 litre per second and wait for the CO<sub>2</sub> value to stabilize and note this, the temperature and the pressure in the calibration sheet.
21. Disconnect the gas from the Bev-a-line before turning of the gas flow.
22. Reconnect the 1 m horizontal white intake tube to the LiCor house with the knurled nut; be careful not to drop the ferrules.
23. Go to 'Li-7200' and 'Flow module' and chose 'Flow': 'on'.
24. Note the values of CO<sub>2</sub> and H<sub>2</sub>O after the zero and span test and make sure that the readings are acceptable.
25. Before disconnecting the RS232 or Ethernet cable from the Licor take a photo of the 'Coefficients' and 'Manual' tab in 'Settings'.

### **11.3.5 Internal chemicals and mirror cleaning**

The internal chemicals should be changed every second a year (preferably in spring when the housing temperature is changed). If values start to look very strange, it could be that the mirror needs cleaning, see the licor7200 manual ('Li-7200, CO<sub>2</sub> analyzer, Instruction manual') for details. A high AGC value indicates how clean the mirrors in the cell are, thus AGC would go up if dirt enters the cell. AGC value should not be above 62. Contact Magnus Lund if the AGC value suddenly increases.

### **11.3.6 Offloading of data from Li-7200**

Offloading of data can be done in two ways. The easiest and quickest way is to change the USB stick in the Li-7200 box. Simply press “eject” on the grey button under the “USB logging”. The red LED will stop flashing and you can remove the USB. After the USB is removed, replace it with another Licor USB. There are three Licor USB’s in Zackenberg; two 16 GB and one 4 GB. Check that all the data is there since last collection. Save data on GeoBasis pc. Format the USB and then it is ready to be put back in Li-7200. **DO NOT FORMAT USB BEFORE YOU HAVE SAVED DATA ON PC.** You can also offload data using the CHG File Transfer 1.02. Programme (see licor7200 manual).

### **11.3.7 Automatic water level measurements at MM2**

Just next to the soil moisture probe that’s connected to the CR1000 data logger, a white water permeable tube is inserted into the soil. Follow the procedure given in section ?? for installation and maintenance of the pressure transducer, into this tube.

### **11.3.8 Automatic camera at MM2**

On the side of the hut, looking northeast towards the two masts a camera has been installed to take automatic photos every third hour (2, 5, 8 and 11 AM and 2, 5, 8 and 11 PM). Follow the procedure described in section 11.2.10 for maintenance of the camera. Photos can be offloaded using the USB cable from the camera, inside the hut.

### **11.3.9 Preparation for winter**

Before the station is left for the winter, the Licor7200 should be span and zero tested, the housing temperature should be changed back to winter mode (5 degrees Celsius), and a full calibration should be performed. Furthermore the power supply should be changed to windmill and solar panels.

## **11.4 Flux monitoring at the Automatic Chamber (AC) site**

The AC site consists of ten automatic chambers from where air is drawn into an instrument box and analysed for methane, carbon dioxide and water vapour. A detailed description of the station is given in a separate manual by Mikhail Mastepanov (CH<sub>4</sub> and CO<sub>2</sub> flux monitoring system\_Zackenberg). This section gives an overview of the additional measurements that are being performed at this site.

## AC

The Methane station is located in the southern part of Rylekæret near Tørvedammen.

Chamber 1: UTM: 8265544 mN, 513271 mE

Chamber 6: UTM: 8265544 mN, 513277 mE

Hut: UTM: 8265542 mN, 513277 mE

M5: UTM: 8265562 mN, 513271 mE

Elevation: 35 m a.s.l.

Operation period: 2006-

Instrumentation: see separate manual

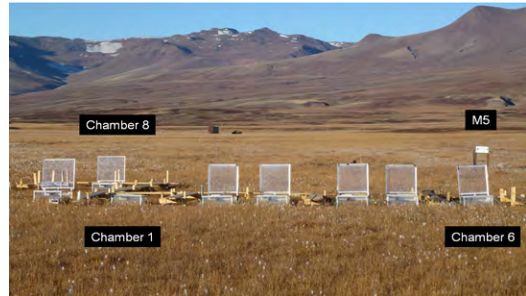

### 11.4.1 Power supply

The station is being powered by the cable that runs from the generator at the station to this site. Next to the power outlet there is a transformer box where 220V is transformed to 12 V. All instruments at this site are running on 12 V. There are 8 accumulators (12 V, 100 Ah) between the power outlet and the instrument box in order to keep the station running continuously also when the generator at the station is turned off.



Figure 76: The battery box (left). A look into the transformer box, inside the hut (mid). Power cable from the instrument box enters the battery box in the southern end –the red and blue cable are connected to plus and minus on the last battery in the row.

### 11.4.2 Soil temperature

Soil temperature are being measured near chamber 1 (K1) and near chamber 6 (K6) and finally between chamber 3 and 4 (Methane). Here TinyTag temperature data loggers are installed at 3 depths (chapter 6). Data loggers are stored in a waterproof box.

1. As soon as the snow melts and the boxes become accessible -data from the tinytags should be offloaded (see chapter 6 for procedure). Name the files: ID\_Xcm\_yyyy-mm-dd (ex: K1\_5cm\_2012-06-03) and save data in the folder: GeoBasis/Tinytags/Methane station. See chapter 6 for offloading loggers and restart.

2. When the loggers are re-started the logging interval must be changed from 1 hour to every 5 minutes which is the logging interval at this site during the field season.
3. Place the data loggers so that you can see the small LED (lights) through the transparent lid of the box, then once in a while during the season you can check that the data loggers are logging (indicated by a green flash).
4. At the end of the season; offload data again and change the battery. Before you start the logger the logging interval must be changed from 5 minutes to 1 hour which is the logging interval during the winter period.

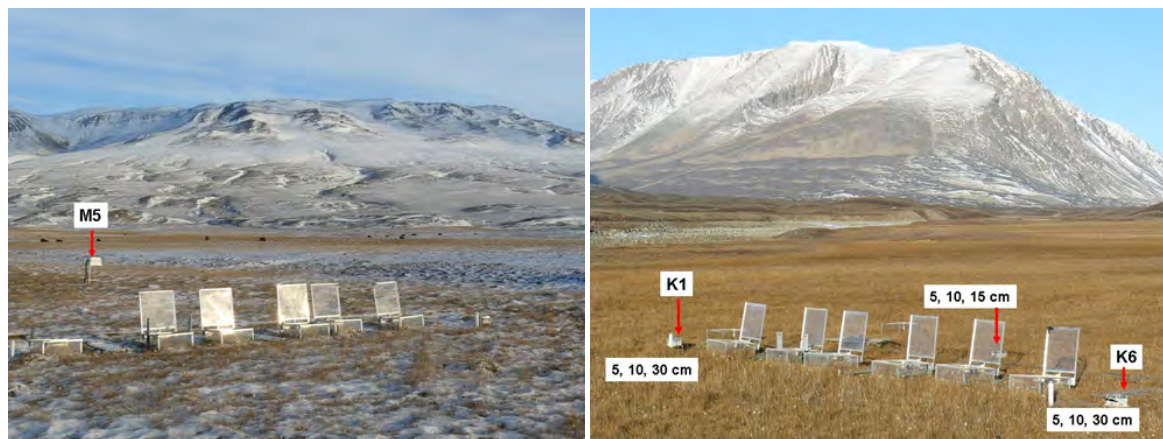

Figure 77: Location of the soil station M5 (left). Location of TinyTag temperature loggers (right).

### 11.4.3 Water table

Changes in water table are registered automatically by two pressure transducers (divers) installed in water permeable tubes near Chamber 1 and Chamber 6. Furthermore it is read manually every day on the water level site (WLS) between Chamber 1 and Chamber 2 (Fig. 78). A Baro diver that registers air pressure and temperature must be installed at the same time (and preferably earlier) as the other divers. Data from the baro diver are needed to compensate the regular divers for changes in air pressure.

#### Installation of divers

As soon as possible the divers must be placed inside the white tubes. Snow has to be melted and a free water table must be present inside the tube so the diver at any time is covered by water.

1. Start the diver and the baro diver at the station. Use the software Diver Office 2009.1 and follow the manual for this program.

Diver settings: Name the diver K1 or K6 respectively (also label the diver on the outside or write down the serial number for each diver so that you place the right diver in the right

tube) Use delayed start and make sure they start at the same time (Check that the time on the computer is right!). Sample method: Fixed. Record interval: 15 minutes.

2. The Baro diver is placed in the open grey tube next to the instrument box.
3. Put a string in the diver and hang it from the screw that crosses the white tube near the top at K1 and K6. The diver must hang freely in the water and not touch the inner tube or the bottom of the tube. Note the length of the string in the field chart.
4. Record the time for installation and measure all the distances asked for in the Field chart 21:

- Distance from top of string to measuring line on the diver.
- Distance from top of white tube to water table.
- Distance from Fix-pole to top of white tube (Next to the white tube there is a metal stick which is drilled into the permafrost. This stick is used as a Fix-point. Whenever the distance from the top of the tube to the water level is measured the distance between the top of the Fix pole and the top of the white tube must also be registered.
- Distance from Top of Fix pole to vegetation surface (not top of grass canopy, but top of denser vegetation).
- Distance from the top of the white tube to the frozen surface inside and outside the tube (early in the season).

**Notice:** In the early season water is frozen inside the tubes. Therefore it might be necessary to change the level of the diver a few times and every time you make any changes remember to record exact time and measure all the distances from the field chart before and after.

**What to do on a daily basis:**

Read water table level at the Water level site (WLS) once a day. Use a folding rule and measure distance from the 0-point and down to the water table. Record the distance with exact day and time in Field chart 20.

**What to do on a weekly basis:**

Measure distance from the top of the white tube to the water table and distance from the Fix pole to the top of the white tube.

Check that the diver is covered by water. If not the diver must be installed deeper (make sure that the diver does not touch the bottom of the white tube).

**Removal of the diver**

Remove the divers when ice starts to form on top of the water inside the tube. (The diver must not freeze in!). Record time for removal and check the distances. Offload data from the diver. Follow the procedure in the Diver Office 2009.1 manual. Save data in

the folder GeoBasis/Diver/Data/YYYY/Original data/K1-diver or Methane\_Baro. The original .mon-file will be altered when you baro compensate the diver data.

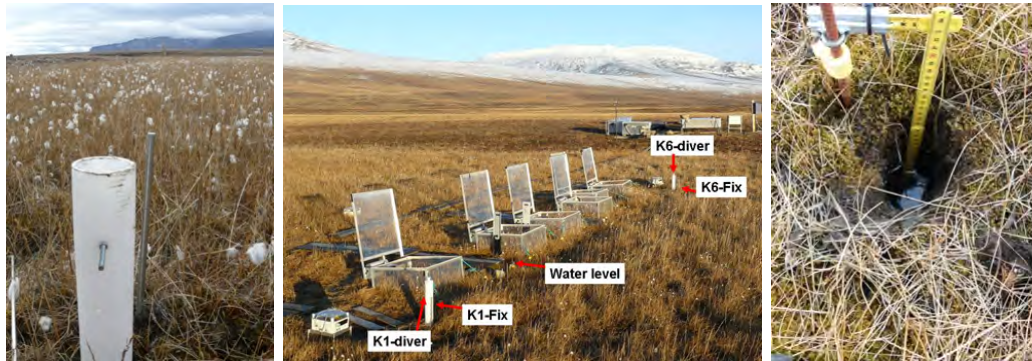

Figure 78: The diver tube K6-diver and the metal probe K6-Fix. The diver is placed so it hangs in a string from the screw that crosses the tube near the top (left). Overview of the methane site with divers and water level site (mid). The water level site (WLS) (right).

#### 11.4.4 Dark chamber measurements

Once every week dark chamber measurements are performed (no need for dark chamber measurements in September and October, since it gets dark during night). Do it after you have done a weekly check of all chambers, where you make sure that they are all functioning properly.

1. A box made for the purpose can be found in the hut.
2. Wait for the chamber to close completely and then place the box over the chamber immediately. Make sure it covers well around the chamber so that no light can reach inside the chamber. Leave it on for the period the chamber is closed. Keep an eye on your watch, remove the box again just before the chamber opens.
3. Move on to the next chamber and repeat the process until you have covered all chambers. Record in the Methane-log-book (on the LGR) when the measurement was performed and details about the weather conditions (cloud cover and so on).

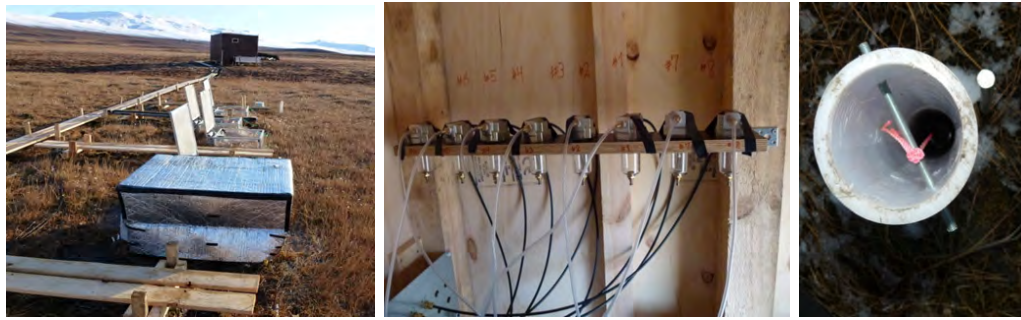

Figure 79: Chamber 2 covered with box for dark chamber measurements (left). Water traps inside the hut (mid). Looking into white tube with diver (right).

#### 11.4.5 Active layer

Every third day the depth of the active layer is measured next to each chamber. The active layer should be measured by the fixed metal probes. Use a metal probe and press it in down in the soil until you feel resistance from the frozen soil. Record the distance from the frozen surface to the top of the fixed metal probes.

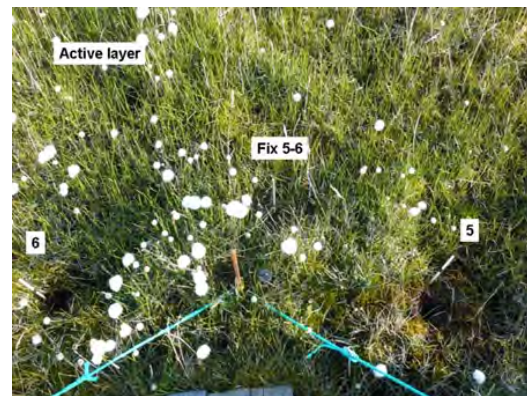

Figure 80: Looking down into the area in front of the chambers. Between the chambers there are fixed metal probes, use the top of these to measure the active layer.

#### 11.4.6 Level measurement

Once during the season (when the soil is frozen!), the level instrument is brought out to the Methane site and relative levels of all Fix points and Installations are measured.

1. Follow the procedure given in separate manual by Lau Gede Petersen. Perform one level measurement with the levelling instrument installed in one place, then move the instrument and repeat the measurements. Take the average of the two measurements.
2. Follow the Field Chart 23 to see the exact points where the level must be determined.

#### **11.4.7 Chamber Volume measurements**

Once a week during the main season, volume is measured in all the chambers. This is done because the volume changes with the flowering and senescence of the vegetation. In the outer seasons it will most probably be necessary to intensify the measurements, because the chambers are filled with fresh snow regularly.

1. in the main season, the distance from the horizontal plane (represented by the lid when this is closed) to the vegetation should be measured in a grid made up of 5 points; NW, NE, the middle, SW and SE.
2. In the outer seasons (when there is snow inside the chambers), the vertical distance is measured in 10x10cm grids (borrow a phenology grid from BioBasis).

#### **11.4.8 Overview of daily check**

- 1) Check the values on the LGR are “normal”.
- 2) Water level is read on a folding rule between chamber 1 and 2

#### **11.4.9 Overview of weekly check**

Once a week during the summer season a complete check round of the chambers is conducted. This is done to ensure that lids are closing tightly and that there are no leaks in the tubing. If this is the case, the graphs on the LGR should increase linearly. In the outer season this check round should be intensified and if the weather is changing a lot it can be necessary to do it every day or every second. After such a round, a round of dark chamber measurements is conducted (see section 11.4.4). Furthermore volume of the chambers (section 11.4.7), distances in relation to divers (section 11.3.3) and active layer is measured.

#### **11.4.10 Troubleshooting**

If a lid is down even though the chamber is not currently running, the problem can be that the split on the motor is worn down and needs changing. In order to do so the lid needs to be dismantled from the base (loosening 6 screws on the inside of the chamber). Then the motor can be dismantled from the frame (remember to remove the power supply first). Use a pincer/plier to remove the old split and press the new one in. Put the motor back into the lid-frame and place the lid on the base again. It can be a tedious exercise and patience is precious.

If the lid is kind of ‘pumping’, even though it is fully closed or opens at the time that it is supposed to be closed, the lid is probably not touching the stop switches properly. They sometimes get a little out of place and a gentle push will get them back on track. Especially



when the chamber is closed, the graph can look strange if the lid is pumping, since this might push some of the air out of the chamber. The stop switches do also have a limited life time. If one suppresses a switch it should give a tick sound. If it does not, it needs to be replaced.

Due to the thawing and freezing of the soil during the season, the frames can move out of their original position. This can result in crooked lids and binding or leakages in one corner or side of the chamber. Try to think how the lid should be placed to fit to the new position and then apply washers between base and lid to direct the lid into the right position once more.

## 12 Geomorphological monitoring

### 12.1 Introduction

The aim of the geomorphological monitoring is to study the changes that occur in the landscape. In the late 90-ties the monitoring was already focused on the changes of the present and former delta-lobes. The changes in morphology and associated sediment budgets were at first monitored at three locations: 1) at cliffs in former delta deposits on the eastern part of the former delta lobe, 2) at a spit and lagoon that was formed on the delta platform of the former delta lobe, and 3) at a cliff on the active delta lobe that was heavily eroding by fluvial activity on the delta platform.

The cliff erosion at the eastern part of the former delta lobe is monitored at four positions (C1-C4), where we yearly measure the perpendicular distance from fixed points to the cliff edge. Analysis of the data already show a spatial gradient, where the distal point (C4) erodes most, already since the beginning, and the proximal point (C1) has been stable over most of the period.

The evolution of the spit that was formed on the platform of the former delta lobe was first monitored through two cross-shore profiles. These cross-shore profiles were measured from the cliffs over the lagoon and spit to the open water and were not exactly perpendicular to the water line. Analysis of the data shows that the spit is slowly migrating landwards and that some old arms of the spit are eroded.

The cliff on the active delta lobe was already eroding in the late 90-ties when the monitoring program was designed. The main reason for this erosion has been the undercutting of the cliff by fluvial activity. The Zackenberg River flows in several channels on the delta platform and its main channel was cutting the cliff foot. The erosion rates have been so large that many of the original fix points were eroded as well. At present, the main channel is centrally located on the delta platform and is not eroding adjacent cliffs.

Since 2008, the shorelines, cliff foots and cross-shore river profiles in the area are also regularly measured with a dGPS, to get a better spatial resolution of the changes in the landscape.

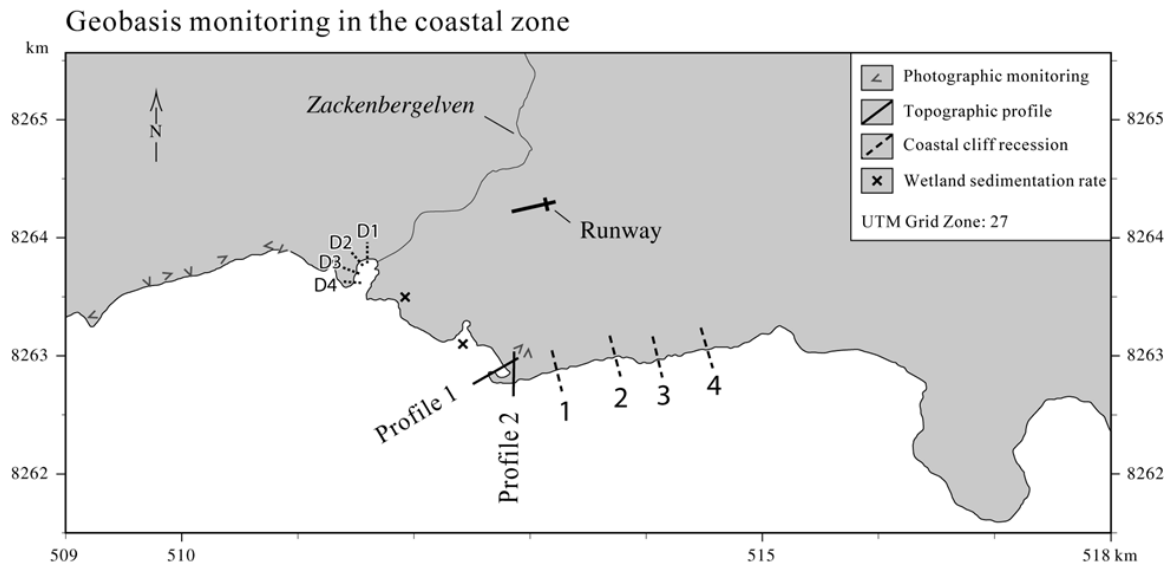

Figure 81: Map showing monitoring sites in the coastal zone.

### 12.1.1 Coastal cliff recession

Coastal cliff recession is surveyed by repeating measurements of the distance between a fixed marker and the edge of the cliff.

#### Location

Coastal retreat rates are monitored along the south coast of Zackenberg dalen (Coastal cliff) and along the delta cliff west of the Zackenbergelven river delta (Fig. 81). Positions of the pegs are given in table 4 and 5.

#### Frequency

Lines are re-surveyed every year in late August.

## Equipment to be used

- Tape measurer
- Peg
- GPS
- Digital camera

Table 4: Positions of coastal cliff pegs

Coastal cliff	Northing	Easting	Year
line 1	8263013	513272	1996
line 2	8263080	513748	1996
line 3	8263065	514026	1996
line 4	8263125	514398	1996

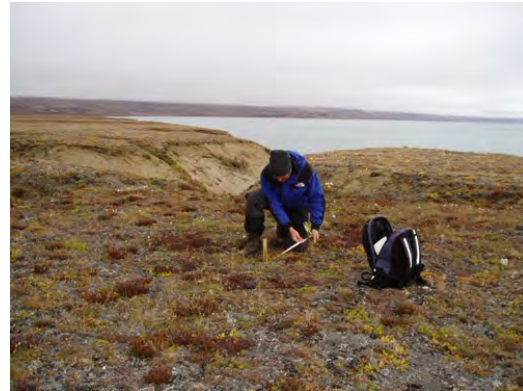

Figure 82: Measurement at the coastal cliff.

Table 5: Positions of delta cliff pegs. Line 3 and 4 has been lost due to erosion

Delta cliff	Northing	Easting	Year
Line 1 D1	8264000	511619	2000
Line 2 D2	8264015	511524	2000

### 12.1.2 Measuring retreat rates

At the coastal cliff wooden pegs with a red top were installed 20 meter from the edge of the cliff in 1996. At the Delta cliff green metal pegs were installed 20 meter from the top of the cliff in 2000.

1. Use the GPS to find the pegs.
2. Survey the perpendicular distance from the centre of the peg to the edge of the cliff, using a tape measure. Behind all pegs there is a small metal peg that must be used to get the correct orientation of the line.
3. Take photos from the site.

### 12.1.3 Maintenance

Paint the pegs (red top) once in a while to help recognize them.

#### 12.1.4 Input of data to the local database

Save results in the file „cliff recession coast and delta“ (GeoBasis/Costal dynamics/cliff recession coast and delta).

#### 12.1.5 Input of data into international database

At the end of the season data from the coastal cliff are reported to Arctic Coastal Dynamics (ACD).

##### Contact

Dr. habil. Volker Rachold  
vrachold@awi-potsdam.de  
www.awi-potsdam.de/acd

### 12.2 Topographic changes at beach profiles

In order to follow the rate of coastal sediment transport two detailed terrain profiles were established in 1991. Profile 1 is a c. 250 m long profile line crossing a curved spit near the old delta. Profile 2 is a c.140 m long profile in an aggrading coastal plain with beach ridges.

##### Location

Location of the profile lines are given in Fig. 83 and 84 and table 6 and 7.

##### Equipment to be used

- Tape measurer
- Peg
- GPS
- Digital camera

Table 6: Position of the pegs in Profile 1. P1e has disappeared or been buried. P1d is almost buried by sand –a metal stick is placed next to it (Fig. 85)

P1	Northing	Easting	m a.s.l.	Marker in the field
P1a	8262971	512861	6.39	Iron peg on gravel plateau
P1b	8262952	512830	5.12	Iron peg on gravel plateau
P1c	8262946	512816		Peg of driftwood
P1d	8262866	512668	0.98	Wooden peg, inner barrier
P1f	8262963	512823		Yellow peg (Photo point)



Figure 83: Looking at the curved spit, Profile 1.

Table 7: Position of the pegs in Profile 2.

P2	Northing	Easting	m a.s.l.	Marker in the field
P2a	8262974	512899	6.13	Iron peg on gravel plateau
P2b	8262934	512904		Peg of driftwood
P2c	8262867	512914	0.99	Iron peg on beach ramp
P2d	8262959	512920		Yellow peg (Photo point)



Figure 84: Topographic measurement at the coastal plain, Profile 2.

### Equipment to be used

- Levelling instrument
- Stage/Tripod
- GPS
- Ranging poles
- Field chart
- Waders
- 2 x VHF-radio
- 2 persons
- Digital camera

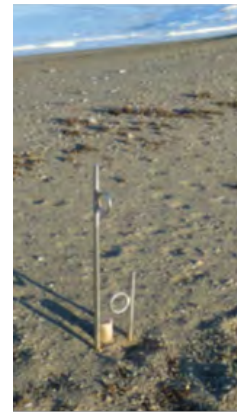

Figure 85: Wodden peg P1d marked by metal sticks.

#### 12.2.1 Survey of topographic profiles

1. Find all pegs in the profile from the UTM coordinates in table 6 and 7 and in App. B.
2. Line up two or three ranging poles in the profile in order to have the line in sight during measurement.
3. Place the tripod on the gravel plateau near the beach/coastal cliff. Make sure the instrument is in the profile line and that the total profile can be measured from the same position.
4. Carefully place the levelling instrument on the tripod. Level the instrument. From this point throughout measurements be careful not to bump or step too close to the tripod legs

as instrument will get out of level.

5. Follow separate manual by Lau Gede Petersen.
6. Start surveying at a point as far out in the water you can wade safely. Move on along the line toward the theodolite station. Survey all points where the vertical angel of the profile changes. Record information about the point in the radio (ex. shore line, in the water, foot of cliff, on top of peg, next to peg, top of beach ridge, etc.....).
7. The person in control of the instrument must guide the prism holder to stay in the line and write down.
8. Place the rod on top of the pegs and next to the pegs. Record when you pass the levelling instrument and start to shoot the other way (180 degrees). The profile ends right behind the last peg on the plateau.
9. Take photo of the line from the photo point on the plateau marked with yellow painted pegs.
10. Move the station to Profile 2 and follow the same procedure as for Profile 1.

**Notice:** Never let the instrument get wet. Close down if it starts to rain. Never point the instrument directly into the sun. Make sure adjusting knobs are loose when you transport the instrument.

### **12.2.2 Input of data to the local database**

Add data into files named: „Profile1(or2)yyyy-mm-dd“ and save them in the GeoBasis directory: (GeoBasis/Coastal monitoring/Topographic profiles).

### **12.2.3 Quick validation**

To be able to compare the topographic profiles adjust the height and length of the profile after the top of the iron peg at the plateau. For profile 1 use P1b=5.12 m a.s.l. and set the length to 0 m at that peg (table 6). For profile 2 use P2a=6.13 m a.s.l. and set the length to 0 m at that peg (table 7).

## **12.3 Detailed mapping of the coastline by DGPS**

Detailed mapping of the coastline is now performed with Differential GPS equipment (present at the station). The mapping is taking place in late August or September every year right after a high tide. It covers the coastline from the trapping station in west to the coastal cliff peg number 4 in the eastern part.

## Equipment to be used

- Differential GPS equipment from House 5
- Handheld yellow Geo XT
- DGPS manual by Lars Holst Hansen
- Manual GPS
- Note book and pen
- Folding rule
- Digital camera
- Separate manual (dGPSInstructions.docx)



Figure 86: Walk along the coastal cliff.

### 12.3.1 Procedure

Follow the procedure given in the DGPS manual on how to use the equipment and how to prepare the base station so that corrections are continuously logged and can be used for later correction/procession of the data.

Go to cliff peg number 4 (the most eastern peg, see Fig. 81. Follow the coastline (as far inland as you can see the water is affecting the coast) and walk in a normal pace.

### 12.3.2 Input of data to local database

All data from the GeoXT and the base station is moved to the folder: GeoBasis/Coastal monitoring/DGPS mapping/Original data.



## Appendix A Instrumentation of GeoBasis installations

Table 8: Meteorological station (M2)

Log interval	Parameter	Unit	Instrumentation	Model	Manufacturer	Elevation
30 min	Battery	Volt		12 V 7.2 Ah	Panasonic	
30 min	Program signal					
30 min	InternalTemp	°C				
30 min	Panel Temp	°C				
30 min	Gust	m/sec	Alpine wind monitor	05103-45	Young	250 cm
30 min	Wind Speed	m/sec	Alpine wind monitor	05103-45	Young	250 cm
30 min	Wind Direction	°	Alpine wind monitor	05103-45	Young	250 cm
30 min	Wind Direction	St.Dev.	Alpine wind monitor	05103-45	Young	250 cm
30 min	Rel. Hum.	%	Temp and Rel hum probe	HC2S3	Rotronic	250 cm
30 min	Air Temperature	°C	Temp and Rel hum probe	MP103A	Campbell Scientific	250 cm
30 min	SoilTemperature	°C	Thermocouple	105T Type T	Campbell Scientific	0 cm
30 min	SoilTemperature	°C	Thermocouple	105T Type T	Campbell Scientific	-10 cm
30 min	SoilTemperature	°C	Thermocouple	105T Type T	Campbell Scientific	-30 cm
30 min	SoilTemperature	°C	Thermocouple	105T Type T	Campbell Scientific	-60 cm
6 hour	Soil moisture	%	Soil moisture probe	Theta-ML2x	Delta-T Cambridge, UK	-10 cm
6 hour	Soil moisture	%	Soil moisture probe	Theta-ML2x	Delta-T Cambridge, UK	-30 cm
6 hour	Snow Depth	cm	Sonic range sensor	SR50a	Campbell Scientific	247 cm
30 min	Red 660		Skye radiation sensor	SKR110	SKYE	250 cm
30 min	NIR		Skye radiation sensor	SKR110	SKYE	250 cm
30 min	RVI		Skye radiation sensor	SKR110	SKYE	250 cm
30 min	NDVI		Skye radiation sensor	SKR110	SKYE	250 cm
30 min	SoilHeat	W/m2	Heat flux plate	HTE3	Campbell Scientific	-1 cm
30 min	Si	W/m2	Net radiometer	CNR1	Kipp & Zonen	250 cm
30 min	Su	W/m2	Net radiometer	CNR1	Kipp & Zonen	250 cm
30 min	Li	W/m2	Net radiometer	CNR1	Kipp & Zonen	250 cm
30 min	Lu	W/m2	Net radiometer	CNR1	Kipp & Zonen	250 cm
30 min	CNR1 Temp	°C	Net radiometer	CNR1	Kipp & Zonen	250 cm
30 min	Net Rs	W/m2				
30 min	Net Ri	W/m2				
30 min	Albedo	%				
30 min	Net Rad	W/m2				
30 min	Li cor	W/m2				
30 min	Lu cor	W/m2				
30 min	Temp Skye	°K				
30 min	Temp Ground	°K				

Table 9: Meteorological station (M3)

Log interval	Parameter	Unit	Instrumentation	Model	Manufacturer	Elevation
30 min	Battery	V		12 V 7,2 Ah	Panasonic	
30 min	Program signal					
30 min	InternalTemp	°C				
30 min	Panel Temp	°C				
30 min	Gust	m/sec	Alpine wind monitor	05103-45	Young	200 cm
30 min	Wind Speed	m/sec	Alpine wind monitor	05103-45	Young	200 cm
30 min	Wind Direction	°	Alpine wind monitor	05103-45	Young	200 cm
30 min	Wind Direction	St.Dev.	Alpine wind monitor	05103-45	Young	200 cm
30 min	Rel. Hum.	%	Temp and Rel hum probe	HC2S3	Rotronic	200 cm
30 min	Air Temperature	°C	Temp and Rel hum probe	MP103A	Campbell Scientific	200 cm
30 min	SoilTemperature	°C	Thermocouple	105T Type T	Campbell Scientific	0 cm
30 min	SoilTemperature	°C	Thermocouple	105T Type T	Campbell Scientific	-10 cm
30 min	SoilTemperature	°C	Thermocouple	105T Type T	Campbell Scientific	-30 cm
30 min	SoilTemperature	°C	Thermocouple	105T Type T	Campbell Scientific	-60 cm
6 hour	Soil moisture	%	Soil moisture probe	Theta-ML2x	Delta-T Cambridge, UK	-10 cm
6 hour	Soil moisture	%	Soil moisture probe	Theta-ML2x	Delta-T Cambridge, UK	-30 cm
6 hour	Snow Depth	Cm	Sonic range sensor	SR50a	Campbell Scientific	188 cm
30 min	Red 660		Skye radiation sensor	SKR110	SKYE	200 cm
30 min	NIR		Skye radiation sensor	SKR110	SKYE	200 cm
30 min	RVI		Skye radiation sensor	SKR110	SKYE	200 cm
30 min	NDVI		Skye radiation sensor	SKR110	SKYE	200 cm
30 min	SoilHeat	W/m2	Heat flux plate	HTF3	Campbell Scientific	-1 cm
30 min	Si	W/m2	Net radiometer	CNR1	Kipp & Zonen	200 cm
30 min	Su	W/m2	Net radiometer	CNR1	Kipp & Zonen	200 cm
30 min	Li	W/m2	Net radiometer	CNR1	Kipp & Zonen	200 cm
30 min	Lu	W/m2	Net radiometer	CNR1	Kipp & Zonen	200 cm
30 min	CNR1 Temp	°C	Net radiometer	CNR1	Kipp & Zonen	200 cm
30 min	Net Rs	W/m2				
30 min	Net Ri	W/m2				
30 min	Albedo	%				
30 min	Net Rad	W/m2				
30 min	Li cor	W/m2				
30 min	Lu cor	W/m2				
30 min	Temp Skye	°K				
30 min	Temp Ground	°K				

Table 10: Micrometeorological station (MM1)

Log interval	Parameter	Unit	Instrumentation	Model	Manufacturer	Elevation
30 min	Carbon dioxide	ppm	Infrared gasanalyzer	Licor-7000	LI-COR, Nebraska, USA	300 cm
30 min	Water vapour	ppt	Infrared gasanalyzer	Licor-7000	LI-COR, Nebraska, USA	300 cm
30 min	IRGA Pressure	hPa	Infrared gasanalyzer	Licor-7000	LI-COR, Nebraska, USA	
30 min	IRGA Temperature	°C	Infrared gasanalyzer	Licor-7000	LI-COR, Nebraska, USA	
30 min	Nominal u	m/s	3D sonic anemometer	R3-100	Gill Instruments, Lynington, UK	300 cm
30 min	Nominal v	m/s	3D sonic anemometer	R3-100	Gill Instruments, Lynington, UK	300 cm
30 min	Nominal w	m/s	3D sonic anemometer	R3-100	Gill Instruments, Lynington, UK	300 cm
30 min	Sonic temperature	°C	3D sonic anemometer	R3-100	Gill Instruments, Lynington, UK	300 cm
30 min	raw_NDVI_red_up_Avg	mV	Skye radiation sensor	SKR1840D	SKYE	378
30 min	raw_NDVI_nir_up_Avg	mV	Skye radiation sensor	SKR1840D	SKYE	378
30 min	raw_NDVI_red_down_Avg	mV	Skye radiation sensor	SKR1840ND	SKYE	378
30 min	raw_NDVI_nir_down_Avg	mV	Skye radiation sensor	SKR1840ND	SKYE	378
30 min	cal_NDVI_red_up_Avg	mV	Skye radiation sensor	SKR1840D	SKYE	378
30 min	cal_NDVI_nir_up_Avg	mV	Skye radiation sensor	SKR1840D	SKYE	378
30 min	cal_NDVI_red_down_Avg	mV	Skye radiation sensor	SKR1840ND	SKYE	378
30 min	cal_NDVI_nir_down_Avg	mV	Skye radiation sensor	SKR1840ND	SKYE	378
30 min	NDVI_Avg	mV	Skye radiation sensor	SKR1840D	SKYE	378
30 min	Incoming_shortwave_radiation_mv_raw	mV	Net radiometer	CNR4	Kipp & Zonen	378
30 min	Outgoing_shortwave_radiation_mv_raw	mV	Net radiometer	CNR4	Kipp & Zonen	378
30 min	Incoming_longwave_radiation_mv_raw	mV	Net radiometer	CNR4	Kipp & Zonen	378
30 min	Outgoing_longwave_radiation_mv_raw	mV	Net radiometer	CNR4	Kipp & Zonen	378
30 min	Incoming_shortwave_radiation_W/m2	W/m2	Net radiometer	CNR4	Kipp & Zonen	378
30 min	Outgoing_shortwave_radiation_W/m2	W/m2	Net radiometer	CNR4	Kipp & Zonen	378
30 min	Incoming_longwave_radiation_W/m2	W/m2	Net radiometer	CNR4	Kipp & Zonen	378
30 min	Outgoing_longwave_radiation_W/m2	W/m2	Net radiometer	CNR4	Kipp & Zonen	378
30 min	CNR4_temperature_°C	°C	Net radiometer	CNR4	Kipp & Zonen	378
30 min	SR50a_distance_raw_m	m	Sonic range sensor	SR50a	Campbell Scientific	378
30 min	SR50a_distance_m	m	Sonic range sensor	SR50a	Campbell Scientific	378
30 min	Snow_depth_from_logger_m	m	Sonic range sensor	SR50a	Campbell Scientific	378
30 min	Snow_depth_cor_m	m	Sonic range sensor	SR50a	Campbell Scientific	378
30 min	Snow_temperature_120cm_°C	°C	Temperature probe	T107	Campbell Scientific	120
30 min	Snow_temperature_90cm_°C	°C	Temperature probe	T107	Campbell Scientific	90
30 min	Snow_temperature_60cm_°C	°C	Temperature probe	T107	Campbell Scientific	60
30 min	Snow_temperature_40cm_°C	°C	Temperature probe	T107	Campbell Scientific	40
30 min	Snow_temperature_20cm_°C	°C	Temperature probe	T107	Campbell Scientific	20
30 min	Snow_temperature_10cm_°C	°C	Temperature probe	T107	Campbell Scientific	10
30 min	Soil_temperature_-2cm_°C2	°C	Temperature probe	T107	Campbell Scientific	-2
30 min	Soil_temperature_-2cm_°C	°C	Temperature probe	T107	Campbell Scientific	-2
30 min	Soil_temperature_-10cm_°C	°C	Temperature probe	T107	Campbell Scientific	-10
30 min	Soil_temperature_-20cm_°C	°C	Temperature probe	T107	Campbell Scientific	-20
30 min	Soil_temperature_-40cm_°C	°C	Temperature probe	T107	Campbell Scientific	-40
30 min	Soil_temperature_-60cm_°C	°C	Temperature probe	T107	Campbell Scientific	-60
30 min	Soil_heat_flux_raw_mv	mV	Hukseflux self-calibrating soil heat flux plate	HFP01SC-10	Campbell Scientific	-4
30 min	Soil_heat_flux_W/m2	W/m2	Hukseflux self-calibrating soil heat flux plate	HFP01SC-10	Campbell Scientific	-4
30 min	Battery_voltage_min_V	V	Battery			
30 min	Battery_voltage_max_V	V	Battery			
30 min	Internal_temperature_°C	°C	Battery			

Table 11: Micrometeorological station (MM2)

Log interval	Parameter	Unit	Instrumentation	Model	Manufacturer	Elevation
30 min	Flux CO2	$\mu\text{mol}/\text{m}^2/\text{s}$	Infrared gasanalyzer	LI-7200	LI-COR	300 cm
30 min	Carbon dioxide	ppm	Infrared gasanalyzer	LI-7200	LI-COR	300 cm
30 min	Water vapour density	$\text{g}/\text{m}^3$				
30 min	Temperature Sonic	$^{\circ}\text{C}$				
30 min	3D Windspeed	$\text{m}/\text{s}$	3D sonic anemometer	Solent 1012R2	Gill Instruments	300 cm
30 min	Wind direction	$^{\circ}$				
30 min	Incoming_shortwave_radiation_mv_raw	mV	Net radiometer	CNR4	Kipp & Zonen	388
30 min	Outgoing_shortwave_radiation_mv_raw	mV	Net radiometer	CNR4	Kipp & Zonen	388
30 min	Incoming_longwave_radiation_mv_raw	mV	Net radiometer	CNR4	Kipp & Zonen	388
30 min	Outgoing_longwave_radiation_mv_raw	mV	Net radiometer	CNR4	Kipp & Zonen	388
30 min	Incoming_shortwave_radiation_W/m <sup>2</sup>	$\text{W}/\text{m}^2$	Net radiometer	CNR4	Kipp & Zonen	388
30 min	Outgoing_shortwave_radiation_W/m <sup>2</sup>	$\text{W}/\text{m}^2$	Net radiometer	CNR4	Kipp & Zonen	388
30 min	Incoming_longwave_radiation_W/m <sup>2</sup>	$\text{W}/\text{m}^2$	Net radiometer	CNR4	Kipp & Zonen	388
30 min	Outgoing_longwave_radiation_W/m <sup>2</sup>	$\text{W}/\text{m}^2$	Net radiometer	CNR4	Kipp & Zonen	388
30 min	CNR4_temperature_ $^{\circ}\text{C}$	$^{\circ}\text{C}$	Net radiometer	CNR5	Kipp & Zonen	388
30 min	SR50a_distance_raw_m	m	Sonic range sensor	SR50a	Campbell Scientific	388
30 min	SR50a_distance_m	m	Sonic range sensor	SR50a	Campbell Scientific	388
30 min	Snow_depth_from_logger_m	m	Sonic range sensor	SR50a	Campbell Scientific	388
30 min	Snow_depth_m	m	Sonic range sensor	SR50a	Campbell Scientific	388
30 min	Air_temperature_ $^{\circ}\text{C}$	$^{\circ}\text{C}$	Temperature and relative humidity sensor	HC2S2	Campbell Scientific	388
30 min	Relative_Humidity_%	%	Temperature and relative humidity sensor	HC2S2	Campbell Scientific	388
30 min	Air_pressure_mbar	mbar	Barometrix pressure sensor	CS100 (Setra 278)	Rotronic	300
30 min	Snow_temperature_120cm_ $^{\circ}\text{C}$	$^{\circ}\text{C}$	Temperature probe	T107	Rotronic	300
30 min	Snow_temperature_90cm_ $^{\circ}\text{C}$	$^{\circ}\text{C}$	Temperature probe	T107	Campbell Scientific	100
30 min	Snow_temperature_60cm_ $^{\circ}\text{C}$	$^{\circ}\text{C}$	Temperature probe	T107	Campbell Scientific	120
30 min	Snow_temperature_40cm_ $^{\circ}\text{C}$	$^{\circ}\text{C}$	Temperature probe	T107	Campbell Scientific	90
30 min	Snow_temperature_20cm_ $^{\circ}\text{C}$	$^{\circ}\text{C}$	Temperature probe	T107	Campbell Scientific	60
30 min	Snow_temperature_10cm_ $^{\circ}\text{C}$	$^{\circ}\text{C}$	Temperature probe	T107	Campbell Scientific	40
30 min	Soil_temperature_-2cm_ $^{\circ}\text{C}$	$^{\circ}\text{C}$	Temperature probe	T107	Campbell Scientific	20
30 min	Soil_temperature_-2cm_ $^{\circ}\text{C}$	$^{\circ}\text{C}$	Temperature probe	T107	Campbell Scientific	10
30 min	Soil_temperature_-10cm_ $^{\circ}\text{C}$	$^{\circ}\text{C}$	Temperature probe	T107	Campbell Scientific	-2
30 min	SoilTemp_50cm_ $^{\circ}\text{C}$	$^{\circ}\text{C}$	Temperature probe	T107	Campbell Scientific	-2
30 min	raw_NDVI_red_up_Avg	mV	Temperature probe	T107	Campbell Scientific	-10
30 min	raw_NDVI_nir_up_Avg	mV	Broken	T107	Campbell Scientific	-20
30 min	raw_NDVI_red_down_Avg	mV	Temperature probe	T107	Campbell Scientific	-50
30 min	raw_NDVI_nir_down_Avg	mV	Temperature probe	T107	Campbell Scientific	388
30 min	cal_NDVI_red_up_Avg	mV	Skye radiation sensor	SKR1840D	SKYE	388
30 min	cal_NDVI_nir_up_Avg	mV	Skye radiation sensor	SKR1840D	SKYE	388
30 min	cal_NDVI_red_down_Avg	mV	Skye radiation sensor	SKR1840ND	SKYE	388
30 min	cal_NDVI_nir_down_Avg	mV	Skye radiation sensor	SKR1840ND	SKYE	388
30 min	NDVI_Avg	mV	Skye radiation sensor	SKR1840ND	SKYE	388
30 min	PAR_raw	$\text{mV}$	PAR sensor	JYP-1000	SKYE	388
30 min	PAR2_raw	$\text{mV}$	PAR sensor	JYP-1000	SDEC	388
30 min	Soil_Heat_Flux_Raw_mv	mV	Hukseflux self-calibrating soil heat flux plate	HFP01SC-10	SDEC	388
30 min	Soil_Heat_Flux_W/m <sup>2</sup>	$\text{W}/\text{m}^2$	Hukseflux self-calibrating soil heat flux plate	HFP01SC-10	Campbell Scientific	-4
30 min	Soil_Heat_Flux_Cor_W/m <sup>2</sup>	$\text{W}/\text{m}^2$	Hukseflux self-calibrating soil heat flux plate	HFP01SC-10	Campbell Scientific	-4
30 min	mean_wind_speed	$\text{m}/\text{s}$	Wind sonic	OPT1 RS232	Gill Instruments limited	388
30 min	mean_wind_direction	degree	Wind sonic	OPT1 RS232	Gill Instruments limited	388
30 min	std_wind_dir	Wind sonic	Wind sonic	OPT1 RS232	Gill Instruments limited	388
30 min	Battery_min_Voltage	V				
30 min	Battery_max_Voltage	V				
30 min	InternalTemp_ $^{\circ}\text{C}$	$^{\circ}\text{C}$				

Table 12: Soil and Meteorological station (M4)

Log interval	Parameter	Unit	Instrumentation	Model	Manufacturer	Elevation
30 min	Battery	V		12V, 24 Ah	Yuasa	
30 min	Program Signal					
30 min	Internal temperature	°C				0 cm
30 min	Panel temperature	°C				-5 cm
30 min	Soil temperature	°C	Thermocouple	105T Type T	Campbell Scientific	-2.5 cm
30 min	Soil temperature	°C	Thermocouple	105T Type T	Campbell Scientific	-10 cm
30 min	Soil temperature	°C	Thermocouple	105T Type T	Campbell Scientific	-20 cm
30 min	Soil temperature	°C	Thermocouple	105T Type T	Campbell Scientific	-30 cm
30 min	Soil temperature	°C	Thermocouple	105T Type T	Campbell Scientific	-40 cm
30 min	Soil temperature	°C	Thermocouple	105T Type T	Campbell Scientific	-60 cm
30 min	Soil temperature	°C	Thermocouple	105E Type E	Campbell Scientific	-125 cm
30 min	Soil temperature	°C	Thermocouple	105E Type E	Campbell Scientific	-150 cm
30 min	Soil temperature	°C	Thermocouple	105E Type E	Campbell Scientific	-250 cm
30 min	Soil temperature	°C	Thermocouple	105E Type E	Campbell Scientific	-300 cm
30 min	Soil temperature	°C	Thermocouple	105E Type E	Campbell Scientific	-323 cm
30 min	Soil moisture	%	Soil moisture probe	Theta-ML2x	Delta-T Cambridge, UK	-5 cm
30 min	Soil moisture	%	Soil moisture probe	Theta-ML2x	Delta-T Cambridge, UK	-10 cm
30 min	Soil moisture	%	Soil moisture probe	Theta-ML2x	Delta-T Cambridge, UK	-30 cm
30 min	Soil moisture	%	Soil moisture probe	Theta-ML2x	Delta-T Cambridge, UK	-50 cm
30 min	Red 660 nm	μmol/m2/s	Skye radiation sensor	SKR 110	SKYE	100 cm
30 min	NIR 730 nm	μmol/m2/s	Skye radiation sensor	SKR 110	SKYE	100 cm
	RV11	Calculated				
	NDVI1	Calculated				
	Red 657nm	μmol/m2/s	Skye radiation sensor	SKR 1800	SKYE	100 cm
	NIR 776 nm	μmol/m2/s	Skye radiation sensor	SKR 1800	SKYE	100 cm
	RV12	Calculated				
	NDVI2	Calculated				
	T-Temp_min	°C	Infrared radiometer	IRR-P 1585	Apogee	100 cm
	T-Temp_avg	°C	Infrared radiometer	IRR-P 1585	Apogee	100 cm
	T-Temp_max	°C	Infrared radiometer	IRR-P 1585	Apogee	100 cm
	RSM300_1	vol%	Soil moisture & temperature sensor	SM300	Dynamax Inc.	-60 cm
	RSM300_2	vol%	Soil moisture & temperature sensor	SM300	Dynamax Inc.	-50 cm
	RSM300_3	vol%	Soil moisture & temperature sensor	SM300	Dynamax Inc.	-40 cm
	RSM300_4	vol%	Soil moisture & temperature sensor	SM300	Dynamax Inc.	-30 cm
	RSM300_5	vol%	Soil moisture & temperature sensor	SM300	Dynamax Inc.	-20 cm
	RSM300_6	vol%	Soil moisture & temperature sensor	SM300	Dynamax Inc.	-20 cm
	RSM300_7	vol%	Soil moisture & temperature sensor	SM300	Dynamax Inc.	-15 cm
	RSM300_8	vol%	Soil moisture & temperature sensor	SM300	Dynamax Inc.	-10 cm
	RSM300_9	vol%	Soil moisture & temperature sensor	SM300	Dynamax Inc.	-5 cm
	SM300_1	°C	Soil moisture & temperature sensor	SM300	Dynamax Inc.	-60 cm
	SM300_2	°C	Soil moisture & temperature sensor	SM300	Dynamax Inc.	-50 cm
	SM300_3	°C	Soil moisture & temperature sensor	SM300	Dynamax Inc.	-40 cm
	SM300_4	°C	Soil moisture & temperature sensor	SM300	Dynamax Inc.	-30 cm
	SM300_5	°C	Soil moisture & temperature sensor	SM300	Dynamax Inc.	-20 cm
	SM300_6	°C	Soil moisture & temperature sensor	SM300	Dynamax Inc.	-20 cm
	SM300_7	°C	Soil moisture & temperature sensor	SM300	Dynamax Inc.	-15 cm
	SM300_8	°C	Soil moisture & temperature sensor	SM300	Dynamax Inc.	-10 cm
	SM300_9	°C	Soil moisture & temperature sensor	SM300	Dynamax Inc.	-5 cm

Table 13: Automatic Chambers (AC)

Log interval	Parameter	Unit	Instrumentation	Model	Manufacturer	Elevation
			See separate manual by Mikhail Mastepanov			

Table 14: Methane site (M5)

Log interval	Parameter	Unit	Instrumentation	Model	Manufacturer	Elevation
10 min	Battery	V		24-12 NP 12V	Yuasa	
10 min	Battery	V				
10 min	Panel Temperature	°C				
10 min	Temperature cor distance	m	Calculated			
10 min	Soil temperature	°C	Thermocouple	107	Campbell Scientific	-2 cm
10 min	Soil temperature	°C	Thermocouple	107	Campbell Scientific	-20 cm
10 min	Soil temperature	°C	Thermocouple	107	Campbell Scientific	-30 cm
10 min	Soil temperature	°C	Thermocouple	107	Campbell Scientific	-40 cm
10 min	Soil temperature	°C	Thermocouple	107	Campbell Scientific	-50 cm
10 min	Soil temperature_initial	°C	Specific heat sensor	Dual probe		-2 cm
10 min	Soil temperature_initial	°C	Specific heat sensor	Dual probe		-8 cm
10 min	Soil temperature_initial	°C	Specific heat sensor	Dual probe		-12 cm
10 min	Soil temperature_initial	°C	Specific heat sensor	Dual probe		-16 cm

Table 15: Meteorological station (M7) Store Sdal

Log interval	Parameter	Unit	Instrumentation	Model	Serial Number	Manufacturer
30 min	Battery V					
30 min	Panel temperature	°C	Pyranometer	SP-lite	075159	Kipp & Zonen
30 min	Si	W/m <sup>2</sup>				
30 min	Air temperature	°C	Temp and rel hum probe	HC2S3	20073231	Rotronic
30 min	Relative humidity	%	Temp and rel hum probe	HC2S3	20073231	Rotronic
30 min	Vapour pressure	kPa				
30 min	Sensor Body temp (SBT)	°C				
30 min	Surface temp (TT)	°C	IRR-P	Apogee	1558	Campbell Scientific
30 min	Wind speed_Avg	m/s	Alpine wind monitor	05103-45	WM151742	Young
30 min	Date and time for max wind speed	dd-mm-yyyy hh:mm				
30 min	Wind speed_Max	m/s	Alpine wind monitor	05103-45	WM151742	Young
30 min	Wind direction	°Geographic N	Alpine wind monitor	05103-45	WM151742	Young
30 min	Std dev					
30 min	Distance from sensor to surface	cm	Sonic range sensor	SR50a		Campbell Scientific
30 min	Signal Quality					
30 min	Snow depth	cm	Sonic range sensor	SR50a		Campbell Scientific

Table 16: Meteorological station (M8) Zackenberg mountain

Log interval	Parameter	Unit	Instrumentation	Model	Manufacturer	Elevation
30 min	PTemp_Avg	°C				
30 min	LithiumBat	V				
30 min	Batvoltage_Avg	V				
30 min	Supply_voltage_Avg	V				
30 min	Windspeed_Avg	m/s	MetPak Pro	1723-PK-200	Gill	Missing
30 min	Winddir_Avg	°Geographic N	MetPak Pro	1723-PK-200	Gill	Missing
30 min	WindDir_StDev		MetPak Pro	1723-PK-200	Gill	Missing
30 min	Gust	m/s	MetPak Pro	1723-PK-200	Gill	Missing
30 min	Temperature_Avg	°C	MetPak Pro	1723-PK-200	Gill	Missing
30 min	Rel_humidity_Avg	%	MetPak Pro	1723-PK-200	Gill	Missing
30 min	Dew_point_Avg	°C	MetPak Pro	1723-PK-200	Gill	Missing



Table 17: Snow Pack Analyzer (SPA)

Log interval	Parameter	Unit	Instrumentation	Model	Manufacturer	Elevation
10 min	IceContent_10cm_%	%	SPA-Sensor		Sommer Messtechnik	10 cm
10 min	WaterContent_10cm_%	%	SPA-Sensor		Sommer Messtechnik	10 cm
10 min	Density_10cm_kgm-3	kg/m <sup>3</sup>	SPA-Sensor		Sommer Messtechnik	10 cm
10 min	SnowWaterEquivalent_10cm_mm	mm	SPA-Sensor		Sommer Messtechnik	10 cm
10 min	IceContent_30cm_%	%	SPA-Sensor		Sommer Messtechnik	30 cm
10 min	WaterContent_30cm_%	%	SPA-Sensor		Sommer Messtechnik	30 cm
10 min	Density_30cm_kgm-3	kg/m <sup>3</sup>	SPA-Sensor		Sommer Messtechnik	30 cm
10 min	SnowWaterEquivalent_30cm_mm	mm	SPA-Sensor		Sommer Messtechnik	30 cm
10 min	IceContent_50cm_%	%	SPA-Sensor		Sommer Messtechnik	50 cm
10 min	WaterContent_50cm_%	%	SPA-Sensor		Sommer Messtechnik	50 cm
10 min	Density_50cm_kgm-3	kg/m <sup>3</sup>	SPA-Sensor		Sommer Messtechnik	50 cm
10 min	SnowWaterEquivalent_50cm_mm	mm	SPA-Sensor		Sommer Messtechnik	50 cm
10 min	Snowdepth_cm	cm	USH-8		Sommer Messtechnik	
10 min	slope_c1_TW_pF	pF	SPA-Sensor		Sommer Messtechnik	
10 min	slope_c2_TW_pF	pF	SPA-Sensor		Sommer Messtechnik	
10 min	horiz1_c1_TW_pF	pF	SPA-Sensor		Sommer Messtechnik	10 cm
10 min	horiz1_c2_TW_pF	pF	SPA-Sensor		Sommer Messtechnik	10 cm
10 min	horiz2_c1_TW_pF	pF	SPA-Sensor		Sommer Messtechnik	30 cm
10 min	horiz2_c2_TW_pF	pF	SPA-Sensor		Sommer Messtechnik	30 cm
10 min	horiz3_c1_TW_pF	pF	SPA-Sensor		Sommer Messtechnik	50 cm
10 min	horiz3_c2_TW_pF	pF	SPA-Sensor		Sommer Messtechnik	50 cm
10 min	SnowScale_mmWc	mmWc	SSG-Snow scale		Sommer Messtechnik	0 cm
10 min	Battery_V	V	Snow Pack Analyzer		Sommer Messtechnik	

Table 18: ICOS Soil station (MM2)

Log interval	Parameter	Unit	Instrumentation	Model	Manufacturer	Elevation
Profile 1						
1 min	Soil heat flux	W/m <sup>2</sup>	Heat flux plate	HFP01SC	Campbell Scientific	-5
1 min	Soil temperature	°C	Thermistor	T107	Campbell Scientific	-2
1 min	Soil temperature	°C	Thermistor	T107	Campbell Scientific	-5
1 min	Soil temperature	°C	Thermistor	T107	Campbell Scientific	-10
1 min	Soil temperature	°C	Thermistor	T107	Campbell Scientific	-20
1 min	Soil temperature	°C	Thermistor	T107	Campbell Scientific	-50
1 min	Soil moisture	m <sup>3</sup> /m <sup>3</sup>	Soil moisture probe	ML3 ThetaProbe	Delta-T Devices	-5
1 min	Soil moisture	m <sup>3</sup> /m <sup>3</sup>	Soil moisture probe	ML3 ThetaProbe	Delta-T Devices	-10
Profile 2						
1 min	Soil heat flux	W/m <sup>2</sup>	Heat flux plate	HFP01SC	Campbell Scientific	-5
1 min	Soil temperature	°C	Thermistor	T107	Campbell Scientific	-2
1 min	Soil temperature	°C	Thermistor	T107	Campbell Scientific	-5
1 min	Soil temperature	°C	Thermistor	T107	Campbell Scientific	-10
1 min	Soil moisture	m <sup>3</sup> /m <sup>3</sup>	Soil moisture probe	ML3 ThetaProbe	Delta-T Devices	-5

## Appendix B GPS positions

**Table 19:** GPS positions for GeoBasis Zackenberg installations

Monitoring site	ID	Northing, mN	Easting, mE	Elev. m a.s.l.	Marking
Photomonitoring	M1	8268397	511090		
	M2	8268397	511090		
	M3	8268397	511090		
	M4	8269657	516581		
	M5a	8264466	512701		
	M5b	8264466	512701		
	M6	8264242	512557		
	M7	8263606	512710		
	M8	8264017	510715		
	M9	8263199	512240		
	M10	8263788	510124		
	M11	8263742	509925		
	M12	8269069	516217		
	M13	8269657	516581		
	M14	8269902	518023		
	M15	8269902	518023		
	M16	8264368	514516		
	M17	8263066	512835		
	M18	8263583	512484		
	M19a	8264466	512016	28	Yellow peg
	M19b	8264466	512016	28	
	M20	8265632	513218		
	M21	8264757	513682		
	M22	8264838	511035		
	M23	8266881	513494	85	
	M24	8265391	513153	40	
	M25	8264664	513378	45	
M26	8263553	511877	6		
M27	8284087	487521	807		
Profile 1	P1a	8262971	512861		Iron peg on gravel plateau
	P1b	8262952	512830		Iron peg on gravel plateau
	P1c	8262946	512816		Peg of driftwood
	P1d	8262866	512668		Wooden peg, inner barrier
	P1e	8262848	512633		Wooden peg, outer barrier
	P1f	8262963	512823		Yellow peg (Photo point)
Profile 2	P2a	8262974	512899		Iron peg on gravel plateau
	P2b	8262934	512904		Peg of driftwood
	P2c	8262867	512914		Iron peg on beach ramp
	P2d	8262959	512920		Yellow peg (Photo point)
Coastal cliff	L1	8263013	513272		Wooden peg, red top
	L2	8263080	513748		Wooden peg, red top
	L3	8263065	514026		Wooden peg, red top
	L4	8263125	514398		Wooden peg, red top
Delta cliff	D1	8264000	511619		Green metal pegs
	D2	8264015	511524	24	Green metal pegs
	D3	8263865	511372		Green metal pegs
	D4	8263764	511379		Green metal pegs
Soil water	Dry-2	8265563	513365		Waterproof box
	Dry-1	8265045	513816	40	Waterproof box
	Sal-2	8264692	513623	32	Waterproof box
	Sal-1	8264649	513045	35	Waterproof box
	Mix1	8264348	513567	33	Waterproof box
	K2	8264760	513365	45	Teflon lines
	K3	8264753	513349	45	Teflon lines
	S2	8263950	513016	10	Teflon lines
	S3	8263950	513016	10	Teflon lines
TinyTag	P1	8263454	512323	20	Stone cairn
	P2	8264257	512713	23	Cancelled
	P3	8268224	515917	400	Stone cairn
	P4	8269597	516936	820	Stone cairn
	P5	8267457	509964	259	Stone cairn
	P6	8263921	513068	11	Cancelled

*Continued on next page*

Table 19 – Continued from previous page

Monitoring site	ID	Northing, mN	Easting, mE	Elev. m a.s.l.	Marking
	S1	8264605	512168	29	Stone cairn
	S2	8264593	512171	25	Stone cairn
	S3	8264588	512171	23	Stone cairn
	S4	8264493	512195	16	Stone cairn
	T1	8268397	511090	85	Stone cairn
	T2	8269215	509105	129	Stone cairn
	T3	8269902	518023	965	Stone cairn
	V1	8264548	512654	14	Cancelled
	V2	8264538	512978	35	Stone cairn
Nansensblokken	T4	8265615	509954	477	Stone cairn
Micrometeorological station	MM1	8264893	513415	40	
Eddy Mast		8264887	513420	40	
Micrometeorological station	MM2				
Flux mast		8265810	513267	40	
Hut (Instruments)		8265817	513283	40	
Climate station	CS	8264700	513400	40	
Snow mast	st644	8264774	513380	40	
Open precipitation gauge		8264751	513388	40	
TDR station		8264747	513377	40	
East	st640	8264738	513384	40	
West	st641	8264735	513375.6	40	
Hydrometric station by the bridge	st 642-2				
Stage level		8265143	512950	14	
642 2 2014 1	Fix1	8265128.226	512980.189	79.405	
642 2 2014 2	Fix2	8265146.124	512958.242	76.111	
642 2 2014 3	Fix3(bridge)	8265119.925	512952.838	75.13	
642 2 2014 4	Fix4	8265104.565	512942.097	74.207	
642 2 2014 5	Fix5	8265276	513100	86.093	
Snow and micromet stations					
In ZC-2 AWS	M2	8264019	513058	17	
Aucella AWS	M3	8268241	516124	420	
Heath soil	M4	8264868	513382	45	Black painted double tripod
Dombjerg AWS (St 647)	M6	8273009	507453	1278	Cancelled
Store Sødal AWS	M7	8269905	496815	145	
Zackenbergs AWS	M8	8287065	508935	1144	
Automatic chamber site	M5	8265562	513271	35	Cancelled
Chamber 1	CH1	8265544	513271		
Chamber 6	CH6	8265542	513277		
Tributaries					
St.Sødal	RS1	8268706	511750		
Lindeman	RS2	8268914	511756		
Palnatoke NW	RS3	8269019	511848		
Palnatoke S	RS4	8268599	512345		
Aucella S	RS5	8266854	512460		
Aucella N	RS6	8268002	512400		
Rylekær	RS7	8265629	513184		
Tørvekær	RS8	8265452	513161		
ZEROCALM-1	1NW	8264856	513363	39	Road marker
	1NE	8264847	513461	39	Road marker
	1SE	8264748	513446	38	Road marker
	1SW	8264758	513347	38	Road marker
ZEROCALM-2	2NW	8264083	513025	19	Road marker
	2NE	8264033	513167	19	Road marker
	2SE	8263920	513127	11	Road marker
	2SW	8263970	512985	9	Road marker
Ice vedge growth	IW1	8264359	512670		Yellow pegs
	IW2	8264109	512624		Yellow pegs
	IW3	8263464	512310		Yellow pegs
Salt marsh accretion	SM	8263363	512415		Iron peg
Sulifuction lobes	SF-3	8264053	512365		Yellow pegs
	SF-2	8264065	512341		Yellow pegs
	SF-1	8265203	515007		Yellow pegs
Wind abrasion	WA	8268397	511090		Stones

Continued on next page

Table 19 – Continued from previous page

Monitoring site	ID	Northing, mN	Easting, mE	Elev. m a.s.l.	Marking
Fix points	FIX A	8264594	512647		Red cross on top of big boulder
	F3	8264600	512763		Peg north of the station
	DPCZ001	8264535	512683	34.78	Metal plate on big boulder/'Gult fixpunkt'
	DPCZ002	8245932	512867	35.35	Drilled hole
	DPCZ003	8264510	512761	35.51	Drilled hole
	DPCZ004	8264738	513404	37.59	Aluminum pipe, approx. 5 cm above terrain
	DPCZ005	8264499	512789	35.51	Bronze plate + bolt
	DPCZ006	8264445	513283	35.54	Aluminum pipe, approx. 5 cm above terrain
	DPCZ007	8263942	511017	3.8	Bronze plate + bolt
	DPCZ008	8263989	512622	23.74	Aluminum pipe, approx. 5 cm above terrain
	DPCZ009	8264342	512624	19.23	Aluminum pipe, approx. 5 cm above terrain
	DPCZ010	8265041	515178	89.15	bolt
	DPCZ011	8267518	513833	126.83	bolt
	DPCZ012	8266960	511869	79.74	bolt
	DPCZ013	8265544	511765	48.54	bolt
	GPS_bolt	8264495	512764	38.674	
ZERO-line	# 155	8269901	518028		Metal peg with plate
	#150	8269916	517760		Metal peg with plate
	#145	8269902	518027		Metal peg with plate
	#137	8269625	516917		Metal peg with plate
	#107	8269219	516555		Metal peg with plate
	#103	8268517	516151		Metal peg with plate
	#99	8268084	515841		Metal peg with plate
	#95	8267598	515464		Metal peg with plate
	#92	8267022	515017		Metal peg with plate
	#91	8266903	514927		Metal peg with plate
	#42	8265315	513804		
	#38	8265176	513714		
	#36	8264977	513591		Metal peg with plate
	#26	8264372	513207		
	#24	8264323	513173		
	#20	8264161	513073		
	#18	8264108	513038		
	#13	8264020	512982		Metal peg with plate
	#12	8264109	513037		
	#11	8263980	512953		Metal peg with plate
#9	8263860	512881		Metal peg with plate	
#5	8263794	512837		Metal peg with plate	
#3	8263772	512824		Metal peg with plate	
#2	8263655	512748		Metal peg with plate	
#1	8263627	512732		Metal peg with plate	
SNM-transect	SNM1	8263425	513503		Start of transect
	SNM2	8263903	513648		Stake 2
	SNM3	8264686	513472		Stake 3
	SNM4	8266093	513538		Stake 5
	SNM5	8267089	513637		Stake 6
	SNM6	8265686	513190		Retning mod stationens mast
	SNM7	8264859	513361		NW-hjørne af ZC-1
SNZ-transect	SNZ-1	8263626	512732		ZL-1 Plate
	SNZ-2	8264110	513038		
	SNZ-3	8264161	513073		
	SNZ-4	8265175	513714		
	SNZ-5	8266178	514341		
	SNZ-6	8266903	514927		
	SNZ-7	8268495	516152		
Repeater station Aucella		8268928	516154		
Cameras					
Delta front	5	8263392	511935	5	Cancelled
Glacier	6	8284444	487814	755	
Nansenblokken	1,2,3	8265615	509954	477	
Glacier AWS (main)		8281811	488870	660	
Glacier AWS		8283962	486083	876	
SIGMA mast	A1	8265149	513741	44	



# Appendix C DOY calendar

DAY OF YEAR (JULIAN) CALENDAR

	1	2	3	4	5	6	7	8	9	10	11	12	13	14	15	16	17	18	19	20	21	22	23	24	25	26	27	28	29	30	31
JAN	1	2	3	4	5	6	7	8	9	10	11	12	13	14	15	16	17	18	19	20	21	22	23	24	25	26	27	28	29	30	31
FEB	32	33	34	35	36	37	38	39	40	41	42	43	44	45	46	47	48	49	50	51	52	53	54	55	56	57	58	59	60		
MAR	61	62	63	64	65	66	67	68	69	70	71	72	73	74	75	76	77	78	79	80	81	82	83	84	85	86	87	88	89	90	
APR	91	92	93	94	95	96	97	98	99	100	101	102	103	104	105	106	107	108	109	110	111	112	113	114	115	116	117	118	119	120	
MAY	121	122	123	124	125	126	127	128	129	130	131	132	133	134	135	136	137	138	139	140	141	142	143	144	145	146	147	148	149	150	151
JUN	152	153	154	155	156	157	158	159	160	161	162	163	164	165	166	167	168	169	170	171	172	173	174	175	176	177	178	179	180	181	
JUL	182	183	184	185	186	187	188	189	190	191	192	193	194	195	196	197	198	199	200	201	202	203	204	205	206	207	208	209	210	211	212
AUG	213	214	215	216	217	218	219	220	221	222	223	224	225	226	227	228	229	230	231	232	233	234	235	236	237	238	239	240	241	242	243
SEP	244	245	246	247	248	249	250	251	252	253	254	255	256	257	258	259	260	261	262	263	264	265	266	267	268	269	270	271	272	273	
OCT	274	275	276	277	278	279	280	281	282	283	284	285	286	287	288	289	290	291	292	293	294	295	296	297	298	299	300	301	302	303	304
NOV	305	306	307	308	309	310	311	312	313	314	315	316	317	318	319	320	321	322	323	324	325	326	327	328	329	330	331	332	333	334	
DEC	335	336	337	338	339	340	341	342	343	344	345	346	347	348	349	350	351	352	353	354	355	356	357	358	359	360	361	362	363	364	365

Add 1 to unshaded values during leap years.





## Appendix E Zackenberg calley map (zones)

